

July
08

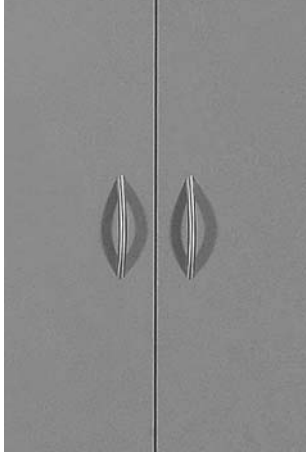
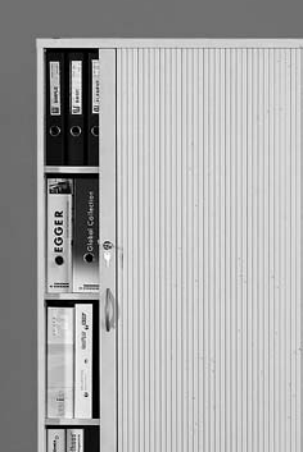

valid from:

OFFICE FURNITURE CABINETS
CABINETS

Contents:

	page
Office cabinets "ECONOMIC"	2
Office cabinets "STANDARD"	18
Hanging file frames for cabinets "ECONOMIC" and "STANDARD".....	59
Pedestals "ECONOMIC"	61
Pedestals "STANDARD"	63
Pedestals "ECONOMIC" and "STANDARD" - accessories	67
METAL pedestals	68
METAL pedestals - accessories	74

MELAMINE FURNITURE COLOUR FINISHINGS

DESK THICKNESS 18 mm

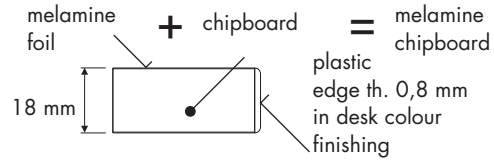

CARCASS COLOUR FINISHINGS

STANDARD COLOUR FINISHINGS

Delivery term of furniture in standard colour finishings is four weeks.



ADDITIONAL COLOUR FINISHINGS

Delivery term of furniture in additional colour finishings is six weeks or by agreement with the seller.



DOOR COLOUR FINISHINGS

STANDARD COLOUR FINISHINGS

Delivery term of furniture in standard colour finishings is four weeks.



ADDITIONAL COLOUR FINISHINGS

Delivery term of furniture in additional colour finishings is six weeks or by agreement with the seller.

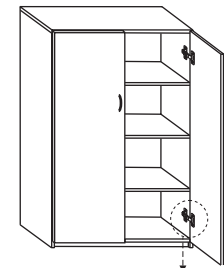
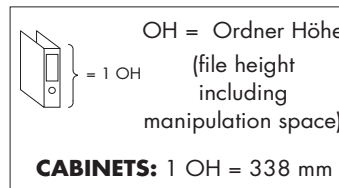
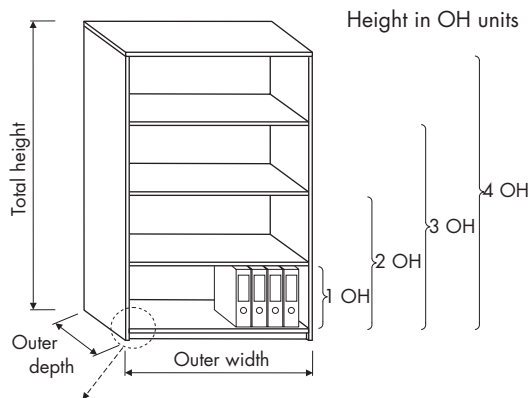
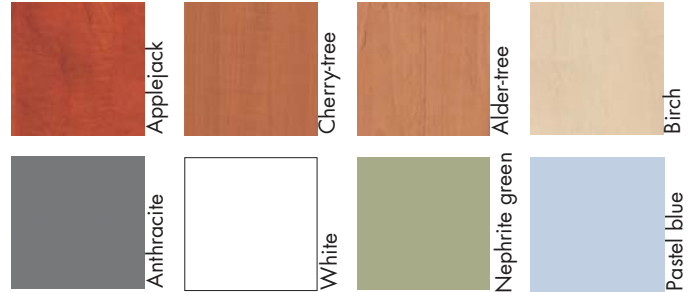

Cabinets carcass: agglutinated with pins



Door hinges Hettich



METAL ROUNDED HANDLES
 colour finishing black or silver



Hinge opening angle 95°



CABINETS "ECONOMIC"

- cabinets with socle
- carcass in UNI finishing
- door in UNI or wooden finishings
- the cabinets are not suitable to be placed in an open space as they don't have a visual back
- glass door: clear glass

Fixed shelf

- fixed into the carcass
- it is not possible to remove the shelf additionally

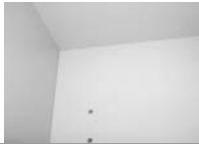

Door covering the carcass



Shelf stabilizers

metal rollers 5/5 mm



Locking with the help of one-way lock



LOCKING SYSTEMS "HÄFELE"

- one-way locks
- two-way locks
- general key available

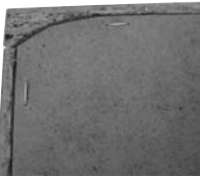

Back fastened to carcass rabbet

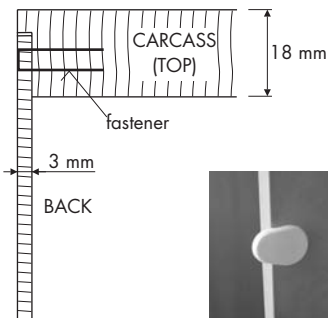
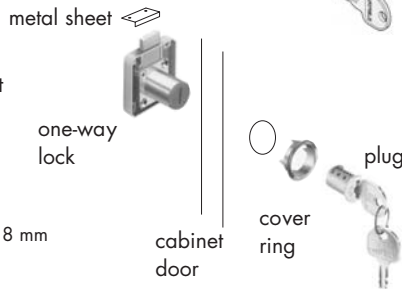

Metal rounded handles in colour finishing black or silver

The handles bolt distance is 96 mm.

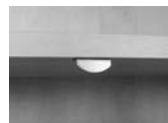

▲ Lock metal sheet

Cabinet socle

Socle on plastic gliders equipped with adjusting elements for floor leveling

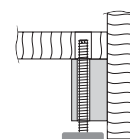

Dimensions are stated in millimetres. The products weight allowance is ± 5%.

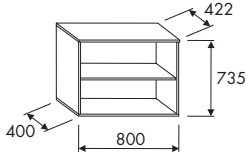
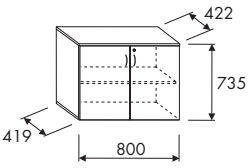
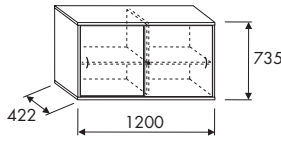
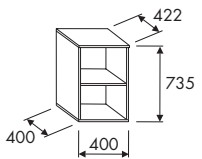
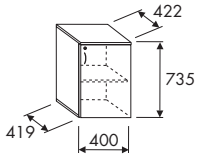
Schema	Description	Weight	Product variant	Art. No.	Price
EXTENSION CABINETS width 800 mm					
	Cabinet open, can be placed next to the desk, cabinet top finishing corresponding to the top of the desk	22,8		SCEO28	80,-
	Cabinet with door, can be placed next to the desk one-way lock available cabinet top finishing corresponding to the top of the desk	32,7	without lock	SCED28	132,10
		32,8	with lock	SCED28L	146,30
width 1200 mm					
	Cabinet with sliding door, can be placed next to the desk, cabinet top finishing corresponding to the top of the desk	48,0	without lock	SCEM22	185,30
		48,1	with lock	SCEM22L	200,40
width 400 mm					
	Cabinet open, can be placed next to the desk, cabinet top finishing corresponding to the top of the desk	15,0		SCEO24	51,50
	Cabinet with door, can be placed next to the desk one-way lock available cabinet top finishing corresponding to the top of the desk	19,5	without lock	SCED24	77,50
		19,6	with lock	SCED24L	91,70

Dimensions are stated in millimetres. The products weight allowance is $\pm 5\%$.

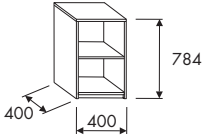
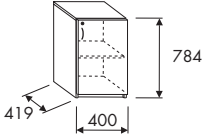
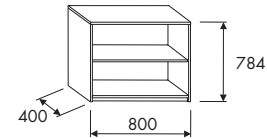
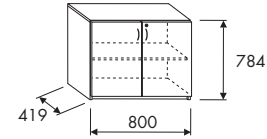
Schema	Description	Weight	Product variant	Art. No.	Price
CABINET OPEN width 400 mm		Kg			EUR
	Cabinet open, - stand-alone, non-extending the working desk	15,5		SCO24	57,60
CABINET WITH DOOR					
	Cabinet with door - one-way lock available - stand-alone, non-extending the working desk	20,5	without lock	SCD24	83,60
		20,6	with lock	SCD24L	97,90
CABINET OPEN width 800 mm					
	Cabinet open, - stand-alone, non-extending the working desk	23,5		SCO28	83,20
CABINET WITH DOOR					
	Cabinet with door - one-way lock available - stand-alone, non-extending the working desk	33,4	without lock	SCD28	135,30
		33,5	with lock	SCD28L	149,50

Dimensions are stated in millimetres. The products weight allowance is ± 5%.

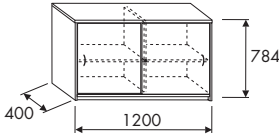
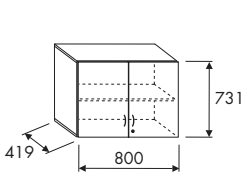
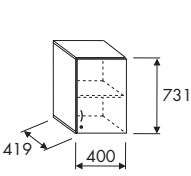
Schema	Description	Weight	Product variant	Art. No.	Price
CABINET WITH DOOR width 1200 mm		Kg			EUR
	Cabinet with sliding door	49,5	without lock	SCM22	185,30
	- one-way lock available - stand-alone, non-extending the working desk	49,6	with lock	SCM22L	200,40
CABINET EXTENSION width 800 mm					
	Cabinet extension with door	32,7	without lock	SCAD28	132,10
	- one-way lock available	32,8	with lock	SCAD28L	146,30
CABINET EXTENSION width 400 mm					
	Cabinet extension with door	19,1	without lock	SCAD24	77,50
	- one-way lock available	19,2	with lock	SCAD24L	91,70

Dimensions are stated in millimetres. The products weight allowance is ± 5%.

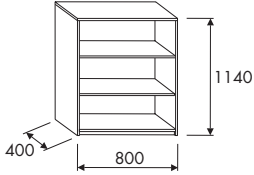
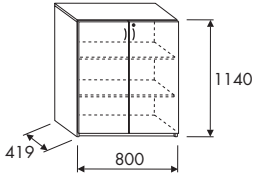
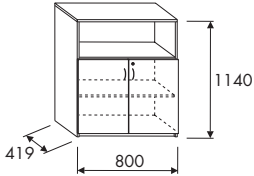
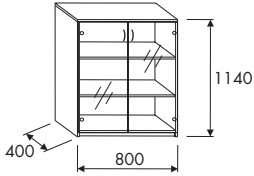
Schema	Description	Weight	Product variant	Art. No.	Price
CABINET OPEN width 800 mm		Kg			EUR
	Cabinet open with shelves	25,0		SCO38	96,40
	CABINET WITH DOOR				
	Cabinet with door	37,2	without lock	SCD38	161,-
	- one-way lock available	37,3	with lock	SCD38L	175,30
CABINET COMBINED					
	Cabinet combined, shelves				
	door/open element	33,2	without lock	SCDO3821	148,80
	- one-way lock available	33,3	with lock	SCDO3821L	163,-
CABINET WITH FULL GLASS DOOR					
	Cabinet with glass door, shelves	37,2	without lock	SCG38	174,50

Dimensions are stated in millimetres. The products weight allowance is ± 5%.

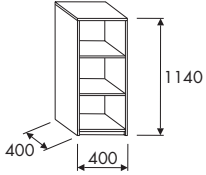
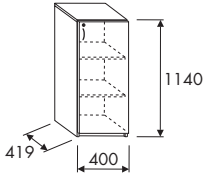
Schema	Description	Weight	Product variant	Art. No.	Price
CABINET OPEN width 400 mm 	Cabinet open with shelves	22,4		SCO34	75,90
CABINET WITH DOOR 	Cabinet with door, shelves - one-way lock available	28,6 28,7	without lock with lock	SCD34 SCD34L	108,10 122,40

Dimensions are stated in millimetres. The products weight allowance is ± 5%.

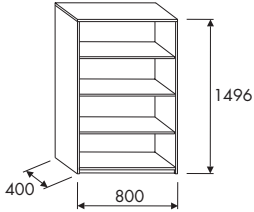
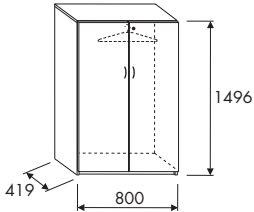
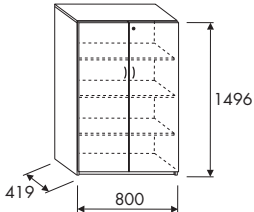
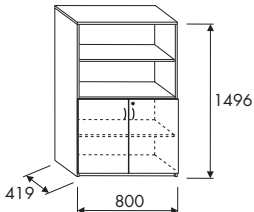
Schema	Description	Weight	Product variant	Art. No.	Price
CABINET OPEN width 800 mm		Kg			EUR
	Cabinet open with shelves	42,4		SCO48	113,40
WARDROBE					
	Wardrobe with door	46,2	without lock	SCW48	173,20
	- equipped with an extractable bar for coat hangers - one-way lock available	46,3	with lock	SCW48L	187,40
CABINET WITH DOOR					
	Cabinet with door	57,8	without lock	SCD48	187,-
	- one-way lock available	57,9	with lock	SCD48L	201,20
CABINET COMBINED					
	Cabinet combined, shelves	50,6	without lock	SCDO4822	165,80
	door/open element - one-way lock available	50,7	with lock	SCDO4822L	180,-

Dimensions are stated in millimetres. The products weight allowance is ± 5%.

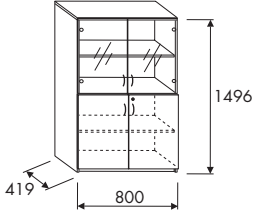
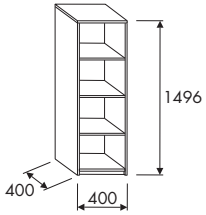
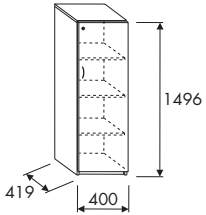
Schema	Description	Weight	Product variant	Art. No.	Price
CABINET COMBINED width 800 mm		Kg			EUR
	Cabinet combined, shelves				
	full door/glass door - one-way lock available only for full door	58,1 58,2	without lock with lock	SCDG4822 SCDG4822L	243,20 257,40
CABINET OPEN width 400 mm					
	Cabinet open with shelves	29,0		SCO44	90,90
CABINET WITH DOOR					
	Cabinet with door				
	- one-way lock available	37,1 37,2	without lock with lock	SCD44 SCD44L	127,60 141,80

Dimensions are stated in millimetres. The products weight allowance is $\pm 5\%$.

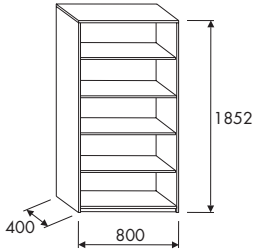
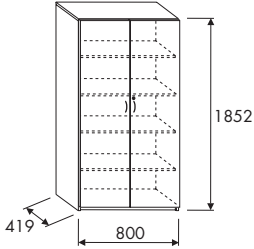
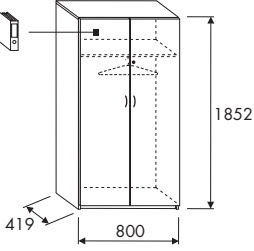
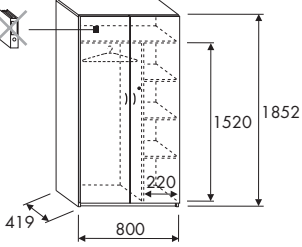
Schema	Description	Weight	Product variant	Art. No.	Price
CABINET OPEN width 800 mm		Kg			EUR
	Cabinet open with shelves	51,5		SCO58	135,80
	CABINET WITH DOOR				
	Cabinet with door				
	- one-way lock available	71,0	without lock	SCD58	221,60
		71,1	with lock	SCD58L	235,90
WARDROBE WITH DOOR					
	Wardrobe with door				
	- equipped with an extractable bar for coat hangers	55,6	without lock	SCW58	202,-
	- one-way lock available	55,7	with lock	SCW58L	216,30
	Wardrobe with door partition, shelves				
	- equipped with an extractable bar for coat hangers	67,3	without lock	SCWS58	239,-
	- one-way lock available	67,4	with lock	SCWS58L	253,20

Dimensions are stated in millimetres. The products weight allowance is ± 5%.

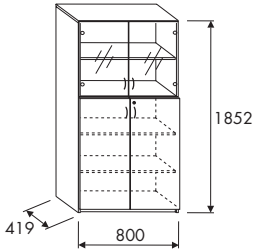
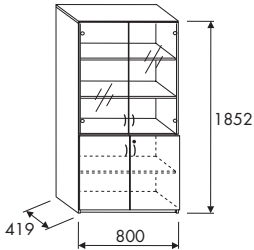
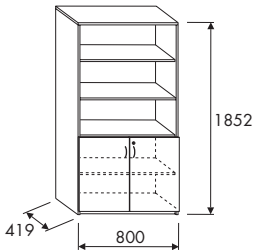
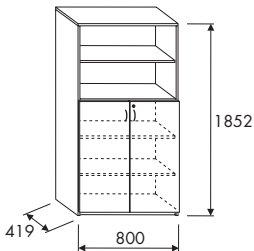
Schema	Description	Weight	Product variant	Art. No.	Price
CABINET COMBINED width 800 mm 	Cabinet combined, shelves				
	full door/glass door - one-way lock available only for full door	71,0 71,1	without lock with lock	SCDG5832 SCDG5832L	265,80 280,-
	Cabinet combined, shelves				
	full door/glass door - one-way lock available only for full door	71,0 71,1	without lock with lock	SCDG5823 SCDG5823L	277,80 292,10
	Cabinet combined, shelves				
	door/open element - one-way lock available	59,7 59,8	without lock with lock	SCDO5823 SCDO5823L	187,80 202,-
	Cabinet combined, shelves				
	door/open element - one-way lock available	63,5 63,6	without lock with lock	SCDO5832 SCDO5832L	200,30 214,50

Dimensions are stated in millimetres. The products weight allowance is ± 5%.

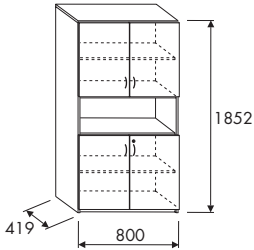
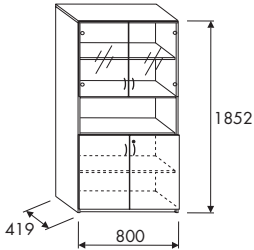
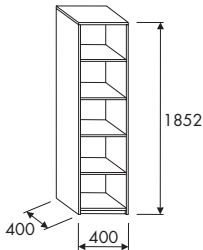
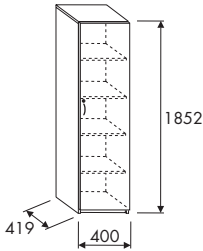
Schema	Description	Weight	Product variant	Art. No.	Price
CABINET COMBINED width 800 mm		Kg			EUR
	Cabinet combined, shelves				
	door/open element/ door	67,9 68,0	without lock with lock	SCDOD58212 SCDOD58212L	239,80 254,-
	Cabinet combined, shelves				
	glass door/ open element/ full door	67,9 68,0	without lock with lock	SCDOG58212 SCDOG58212L	265,30 279,50
CABINET OPEN width 400 mm					
	Cabinet open with shelves				
		35,5		SCO54	114,30
CABINET WITH DOOR					
	Cabinet with door				
	- one-way lock available	45,5 45,6	without lock with lock	SCD54 SCD54L	157,20 171,40

Dimensions are stated in millimetres. The products weight allowance is $\pm 5\%$.

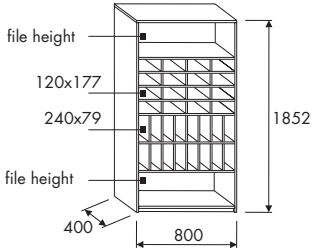
Schema	Description	Weight		Art. No.	Price
CABINET FOR LETTERS AND OTHER CORRESPONDENCE		Kg			EUR
	<p>Cabinet for arrival letters and other correspondence</p> <ul style="list-style-type: none"> - pigeon-holes for different sizes of consignments - file shelves 	93,8		SCO58T	319,20

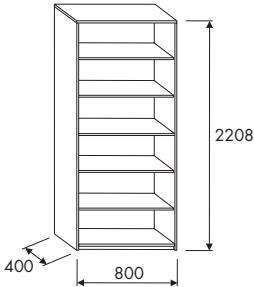
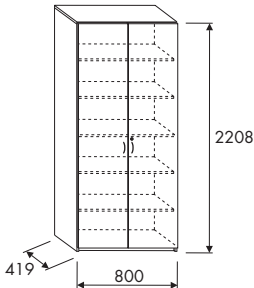
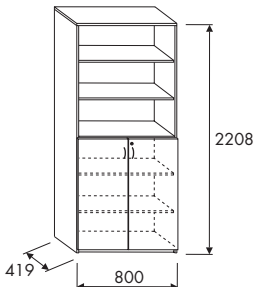

Dimensions are stated in millimetres. The products weight allowance is ± 5%.

Schema	Description	Weight	Product variant	Art. No.	Price
CABINET OPEN width 800 mm 	Cabinet open with shelves	Kg 60,6		SCO68	EUR 166,60
CABINET WITH DOOR 	Cabinet with door - one-way lock available	84,8 84,9	without lock with lock	SCD68 SCD68L	260,60 274,80
CABINET COMBINED 	Cabinet combined, shelves door/open element - one-way lock available	72,6 72,7	without lock with lock	SCDO6833 SCDO6833L	231,30 245,50

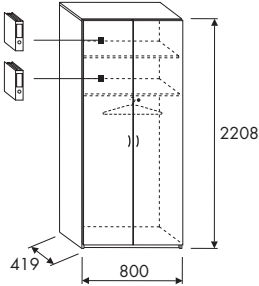
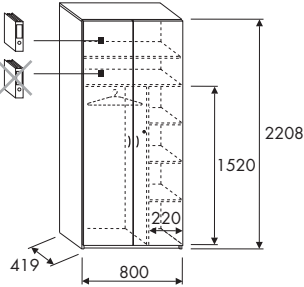
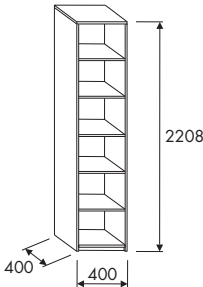
Dimensions are stated in millimetres. The products weight allowance is $\pm 5\%$.

Schema	Description	Weight	Product variant	Art. No.	Price
WARDROBE width 800 mm		Kg			EUR
	Wardrobe with door				
	- equipped with 2 shelves and 1 extractable bar for coat hangers - one-way lock available	69,2 69,3	without lock with lock	SCW68 SCW68L	239,- 253,30
	Wardrobe with partition, door				
	- equipped with 2 shelves and 1 extractable bar for coat hangers - one-way lock available	80,9 81,0	without lock with lock	SCWS68 SCWS68L	277,50 291,70
CABINET OPEN width 400 mm					
	Cabinet open with shelves	42,1		SCO64	135,80

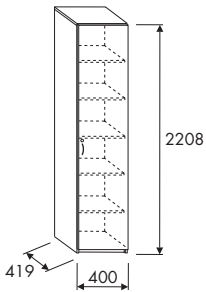
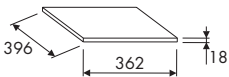
Dimensions are stated in millimetres. The products weight allowance is $\pm 5\%$.

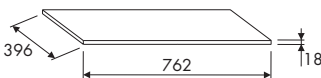
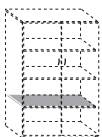
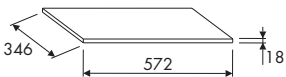
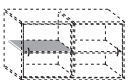
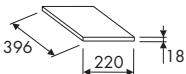
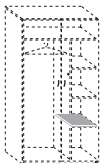
Schema	Description	Weight	Product variant	Art. No.	Price
CABINET WITH DOOR width 400 mm		Kg			EUR
	Cabinet with door				
	- one-way lock available	54,1	without lock	SCD64	182,70
		54,2	with lock	SCD64L	196,90
for cabinets type "SCO", "SCD"					
width 400 mm					
 	additional shelf for width 400 mm	2,2	additional shelf	SSW04F4	6,80
	- including stabilizers				
for type "SCO", "SCD" and combined cabinets					
width 800 mm					
 	additional shelf for width 800 mm	3,9	additional shelf	SSW08F4	10,40
	- including stabilizers				
for cabinets type "SCM"					
width 1200 mm					
 	additional shelf for cabinet with sliding door 1200 mm	2,8	additional shelf	SSWM12F4	8,90
	- including stabilizers				
for cabinets type "SCWS"					
width 220 mm					
 	additional shelf for wardrobe with partition	1,2	additional shelf	SSWS02F4	6,10
	- including stabilizers				

OFFICE CABINETS "STANDARD"

MELAMINE FURNITURE COLOUR FINISHINGS

FOR THICKNESS:

- 18 mm
- 25 mm

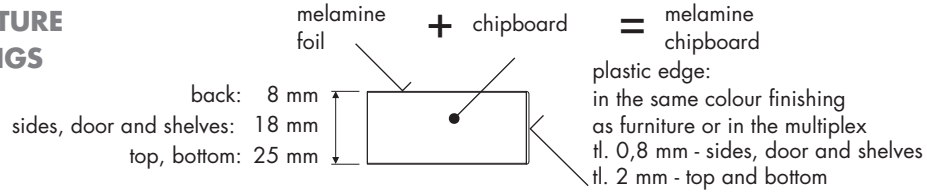

STANDARD COLOUR FINISHINGS

Delivery term of furniture in standard colour finishings is four weeks.



ADDITIONAL COLOUR FINISHINGS

Delivery term of furniture in additional colour finishings is six weeks or by agreement with the seller.



DOOR COLOUR FINISHINGS

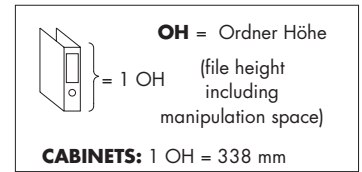
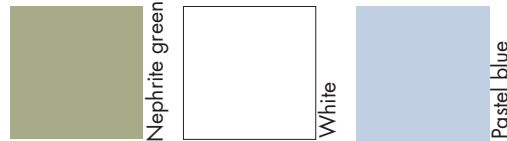

SHUTTER DOOR FINISHINGS

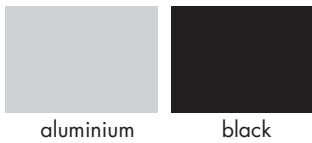

Cabinet with shutter door



Häfele locks



Hinge opening angle 95°



Metal rounded handles in colour finishings silver or black



Cabinets carcass: dismantlable metal connectors



Door hinges Hettich

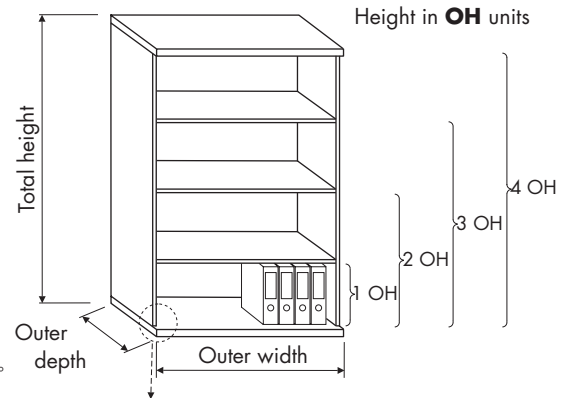
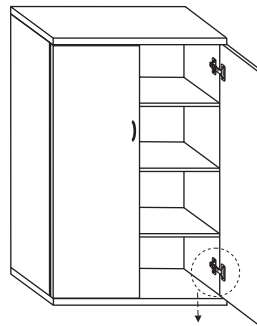



CABINETS "STANDARD"

- carcass in UNI or wooden colour finishings
- door in UNI or wooden colour finishings
- the cabinets are suitable to be placed in an open space as they have a visual back
- glass door: clear glass

Fixed shelf

- attached in the carcass with the help of metal fittings
- if necessary it is possible to take the shelf out

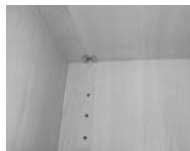

Door is placed between top and bottom
The top can be equipped with the multiplex edge



Safety shelves stabilizers

- preventing the fall out of the shelves
- additional shelves have holes for the safety shelves stabilizers



Locking with the help of one-way lock



LOCKING SYSTEMS "HÄFELE"

- one-way locks
- two-way locks
- general key available



Melamine back fixed to the rabbet on the carcass

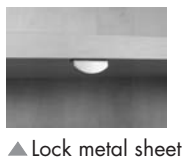
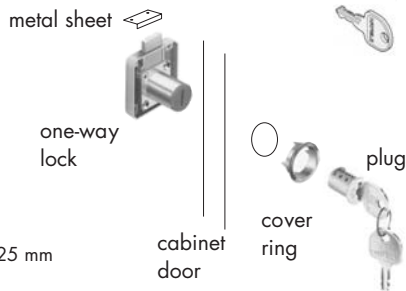
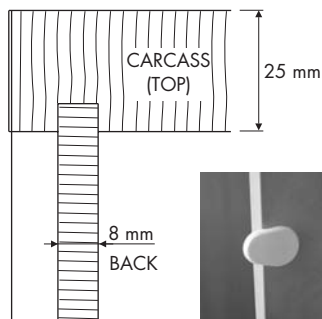

Metal rounded handles in colour finishings silver or black

The handles bolt distance is 96 mm.



Cabinets bottom with adjusting elements for floor levelling

- the rectification is regulated by the allen head screw
- the vent for the rectification is covered by a plastic plug.

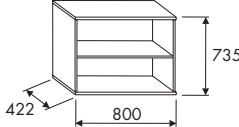
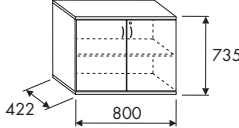
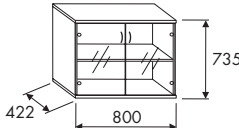
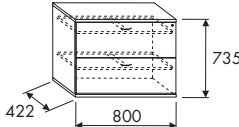
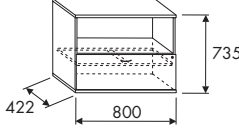

Dimensions are stated in millimetres. The products weight allowance is ± 5%.

Schema	Description	Weight	Product variant	Art. No.	Price
CABINET OPEN width 800 mm		Kg			EUR
	Cabinet open with shelves	27,0		ECO0748	107,80
CABINET WITH DOOR					
	Cabinet with door				
	- one-way lock available	34,4	without lock	ECD0748	159,90
		34,5	with lock	ECD0748L	174,10
CABINET WITH GLASS DOOR					
	Cabinet with glass door	33,3		ECG0748	185,30
CABINET WITH HANGING FILE FRAMES					
HANGING FILE FRAMES WITH THE FRONT PANELS	Cabinet with hanging file frames	41,5	without lock	ECR0748	345,80
	- 2 hanging file frames	41,7	with lock	ECR0748L	385,-
	- central locking available				
CABINET WITH HANGING FILE FRAME - COMBINED					
HANGING FILE FRAMES WITH THE FRONT PANELS	Cabinet with hanging file frame - combined				
	- 1 hanging file frame	36,3	without lock	ECRO0748	231,60
	- open element	36,4	with lock	ECRO0748L	245,80
	- central locking available				

Dimensions are stated in millimetres. The products weight allowance is ± 5%.

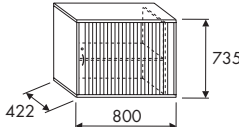
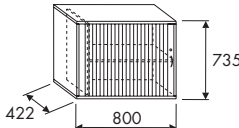
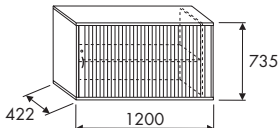
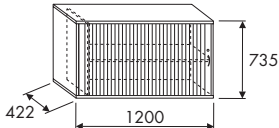
Schema	Description	Weight	Shutter door colour	Product variant	Art. No.	Price
CABINETS WITH SHUTTER DOOR width 800 mm		Kg				EUR
	Cabinet with shutter door, right-handed shutter colour finishings: - black - aluminium	35,9	black	without lock	ECS07485	196,20
		36,0		with lock	ECS07485L	223,10
	- one-way lock available	35,9	aluminium	without lock	ECS07486	211,30
		36,0		with lock	ECS07486L	238,30
	Cabinet with shutter door, left-handed shutter colour finishings: - black - aluminium	35,9	black	without lock	ECSL7485	196,20
		36,0		with lock	ECSL7485L	223,10
	- one-way lock available	35,9	aluminium	without lock	ECSL7486	211,30
		36,0		with lock	ECSL7486L	238,30
width 1200 mm						
	Cabinet with shutter door, right-handed shutter colour finishings: - black - aluminium	48,4	black	without lock	ECS07425	276,40
		48,5		with lock	ECS07425L	303,40
	- one-way lock available	48,4	aluminium	without lock	ECS07426	299,80
		48,5		with lock	ECS07426L	326,80
	Cabinet with shutter door, left-handed shutter colour finishings: - black - aluminium	48,4	black	without lock	ECSL7425	276,40
		48,5		with lock	ECSL7425L	303,40
	- one-way lock available	48,4	aluminium	without lock	ECSL7426	299,80
		48,5		with lock	ECSL7426L	326,80

Dimensions are stated in millimetres. The products weight allowance is ± 5%.

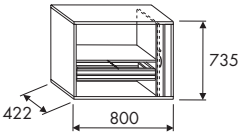
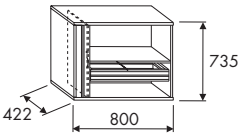
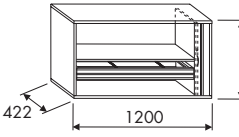
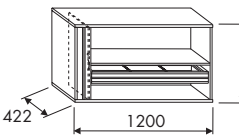
Schema	Description	Weight	Product variant	Art. No.	Price	
CABINETS WITH HANGING FILE FRAMES AND SHUTTER DOOR						
 <p>width 800 mm</p> <p>Hanging file frame for 1 row of files</p> <p>one-way lock available</p>	<p>Cabinets with shutter door right-handed</p> <ul style="list-style-type: none"> - 1x shelf - 1x hanging file frame - 1x crossbar in colour: black <p>shutter colour finishings:</p> <ul style="list-style-type: none"> - black - aluminium 	41,9	black	without lock	ECST07485	413,70
		42,0		with lock	ECST07485L	440,60
		41,9	aluminium	without lock	ECST07486	428,80
		42,0		with lock	ECST07486L	455,80
 <p>width 800 mm</p> <p>Hanging file frame for 1 row of files</p> <p>one-way lock available</p>	<p>Cabinets with shutter door left-handed</p> <ul style="list-style-type: none"> - 1x shelf - 1x hanging file frame - 1x crossbar in colour: black <p>shutter colour finishings:</p> <ul style="list-style-type: none"> - black - aluminium 	41,9	black	without lock	ECSTL7485	413,70
		42,0		with lock	ECSTL7485L	440,60
		41,9	aluminium	without lock	ECSTL7486	428,80
		42,0		with lock	ECSTL7486L	455,80
width 1200 mm						
 <p>width 1200 mm</p> <p>Hanging file frame 735 for 2 rows of files</p> <p>one-way lock available</p>	<p>Cabinets with shutter door right-handed</p> <ul style="list-style-type: none"> - 1x shelf - 1x hanging file frame - 2x crossbars in colour: black <p>shutter colour finishings:</p> <ul style="list-style-type: none"> - black - aluminium 	57,4	black	without lock	ECST07425	510,-
		57,5		with lock	ECST07425L	536,90
		57,4	aluminium	without lock	ECST07426	533,40
		57,5		with lock	ECST07426L	560,30
 <p>width 1200 mm</p> <p>Hanging file frame 735 for 2 rows of files</p> <p>one-way lock available</p>	<p>Cabinets with shutter door left-handed</p> <ul style="list-style-type: none"> - 1x shelf - 1x hanging file frame - 2x crossbars in colour: black <p>shutter colour finishings:</p> <ul style="list-style-type: none"> - black - aluminium 	57,4	black	without lock	ECSTL7425	510,-
		57,5		with lock	ECSTL7425L	536,90
		57,4	aluminium	without lock	ECSTL7426	533,40
		57,5		with lock	ECSTL7426L	560,30

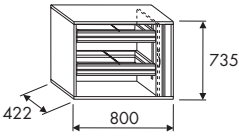
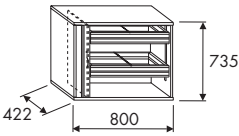
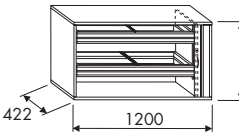
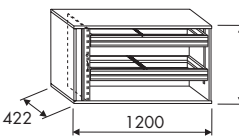

Dimension are stated in millimetres. The products weight allowance is ± 5%.

Schema	Description	Weight	Product variant	Art. No.	Price	
CABINETS WITH HANGING FILE FRAMES AND SHUTTER DOOR						
 <p>width 800 mm</p> <p>Hanging file frame for 1 row of files</p> <p>one-way lock available</p>	<p>Cabinet with shutter door right-handed</p> <p>- 2x hanging file frames</p> <p>- 2x crossbars</p> <p>in colour: black</p> <p>shutter colour finishings:</p> <p>- black</p> <p>- aluminium</p>	<p>Kg</p> <p>47,9</p> <p>48,0</p> <p>47,9</p> <p>48,0</p>	Shutter door colour		EUR	
			black	without lock	ECST207485	643,30
				with lock	ECST207485L	670,30
			aluminium	without lock	ECST207486	658,50
with lock	ECST207486L	685,50				
 <p>width 800 mm</p> <p>Hanging file frame for 1 row of files</p> <p>one-way lock available</p>	<p>Cabinet with shutter door left-handed</p> <p>- 2x hanging file frames</p> <p>- 2x crossbars</p> <p>in colour: black</p> <p>shutter colour finishings:</p> <p>- black</p> <p>- aluminium</p>	<p>47,9</p> <p>48,0</p> <p>47,9</p> <p>48,0</p>	black	without lock	ECST2L7485	643,30
				with lock	ECST2L7485L	670,30
			aluminium	without lock	ECST2L7486	658,50
				with lock	ECST2L7486L	685,50
width 1200 mm						
 <p>width 1200 mm</p> <p>Hanging file frame 735 for 2 rows of files</p> <p>one-way lock available</p>	<p>Cabinet with shutter door right-handed</p> <p>- 2x hanging file frames</p> <p>- 4x crossbars</p> <p>in colour: black</p> <p>shutter colour finishings:</p> <p>- black</p> <p>- aluminium</p>	<p>66,4</p> <p>66,5</p> <p>66,4</p> <p>66,5</p>	black	without lock	ECST207425	755,60
				with lock	ECST207425L	782,60
			aluminium	without lock	ECST207426	779,-
				with lock	ECST207426L	806,-
 <p>width 1200 mm</p> <p>Hanging file frame for 2 rows of files</p> <p>one-way lock available</p>	<p>Cabinet with shutter door left-handed</p> <p>- 2x hanging file frames</p> <p>- 4x crossbars</p> <p>in colour: black</p> <p>shutter colour finishings:</p> <p>- black</p> <p>- aluminium</p>	<p>66,4</p> <p>66,5</p> <p>66,4</p> <p>66,5</p>	black	without lock	ECST2L7425	755,60
				with lock	ECST2L7425L	782,60
			aluminium	without lock	ECST2L7426	779,-
				with lock	ECST2L7426L	806,-

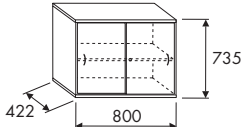
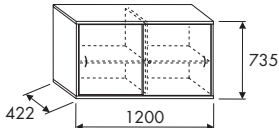
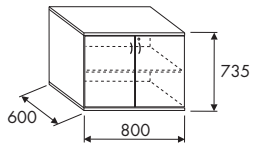
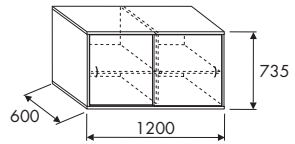
Dimensions are stated in millimetres. The products weight allowance is $\pm 5\%$.

Schema	Description	Weight	Product variant	Art. No.	Price
CABINET WITH SLIDING DOOR 800 mm		Kg			EUR
	Cabinet with sliding door	35,5	without lock	ECM0748	171,30
	- one-way lock available	35,6	with lock	ECM0748L	186,40
CABINET WITH SLIDING DOOR 1200 mm					
	Cabinet with sliding door	56,4	without lock	ECM0742	199,40
	- one-way lock available	56,5	with lock	ECM0742L	214,50
CABINET UNDER THE COPIER 800 mm					
	Cabinet with sliding door to be placed under the copier	46,0	without lock	ECD20748	179,90
	- one-way lock available	46,1	with lock	ECD20748L	194,10
CABINET UNDER THE COPIER 1200 mm					
	Cabinet with sliding door to be placed under the copier	73,8	without lock	ECM20742	228,80
	- one-way lock available	73,9	with lock	ECM20742L	243,90

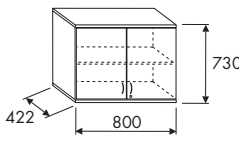
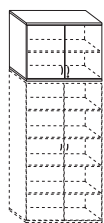
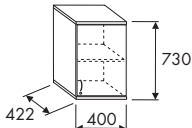
Dimensions are stated in millimetres. The products weight allowance is ± 5%.

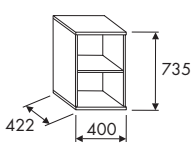
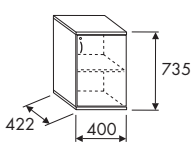
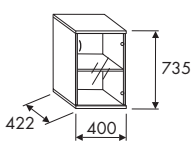
Schema	Description	Weight	Product variant	Art. No.	Price
EXTENSION CABINETS width 800 mm		Kg			EUR
 	Extension cabinet with door	34,3	without lock	ECAD0748	155,30
	- one-way lock available	34,4	with lock	ECAD0748L	169,50
EXTENSION CABINETS width 400 mm					
 	Extension cabinet with door	20,3	without lock	ECAD0744	99,90
	- one-way lock available	20,4	with lock	ECAD0744L	114,20
CABINET OPEN width 400 mm					
	Cabinet open with shelves	16,8		ECO0744	77,40
CABINET WITH DOOR					
	Cabinet with door	20,4	without lock	ECD0744	104,50
	- one-way lock available	20,5	with lock	ECD0744L	118,80
CABINET WITH GLASS DOOR					
	Cabinet with glass door	20,3		ECG0744	142,-

Dimensions are stated in millimetres. The products weight allowance is ± 5%.

Schema	Description	Weight	Art. No.	Price
<p>CORNER CABINET outer</p>	<p>Corner cabinet outer</p> <p>1x shelf</p>	<p>Kg</p> <p>13,9</p>	<p>ECC0744</p>	<p>EUR</p> <p>136,20</p>
<p>inner</p>	<p>Corner cabinet inner</p> <p>1x shelf</p>	<p>42,0</p>	<p>ECC0748</p>	<p>226,-</p>

Dimensions are stated in millimetres. The products weight allowance is $\pm 5\%$.

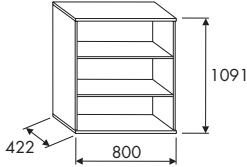
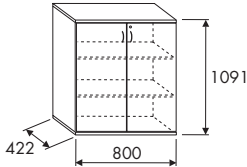
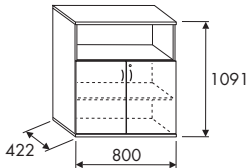
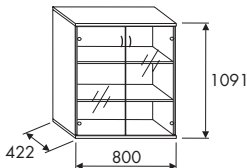
Schema	Description	Weight	Product variant	Art. No.	Price
CABINET OPEN width 800 mm		Kg			EUR
	Cabinet open with shelves	36,8		ECO1098	122,80
CABINET WITH DOOR					
	Cabinet with door				
	- one-way lock available	47,9	without lock	ECD1098	187,30
		48,0	with lock	ECD1098L	201,50
CABINET COMBINED					
	Cabinet combined				
	- door/open element	44,8	without lock	ECDO109821	175,40
	- one-way lock available	44,9	with lock	ECDO109821L	189,60
CABINET WITH GLASS DOOR					
	Cabinet with glass door				
		47,6		ECG1098	200,80

Dimensions are stated in millimetres. The products weight allowance is $\pm 5\%$.

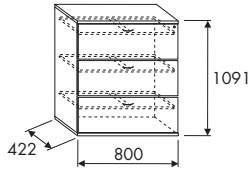
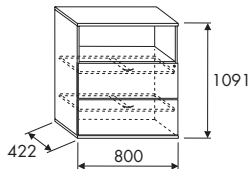
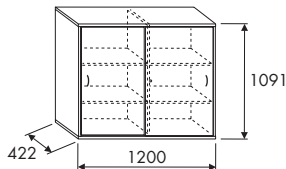
Schema	Description	Weight	Product variant	Art. No.	Price
CABINET WITH HANGING FILE FRAME					
HANGING FILE FRAMES WITH THE FRONT PANELS					
	Cabinet with hanging file frames				
	- 3 hanging file frames	56,5	without lock	ECR1098	474,90
	- central locking available	56,7	with lock	ECR1098L	517,90
CABINET WITH HANGING FILE FRAME - COMBINED					
HANGING FILE FRAMES WITH THE FRONT PANELS					
	Cabinet with hanging file frames				
	- 2 hanging file frames	51,3	without lock	ECRO109821	360,60
	- open element	51,5	with lock	ECRO109821L	399,90
	- central locking available				
CABINET WITH SLIDING DOOR 1200 mm					
	Cabinet with sliding door				
	- one-way lock available	80,0	without lock	ECM1092	233,10
		80,1	with lock	ECM1092L	248,20

WARNING: The hanging file frames are not equipped with the antitilt device and therefore it's necessary to secure the cabinet against possible tilt, preferably fixing it to the wall.

Dimensions are stated in millimetres. The products weight allowance is ± 5%.

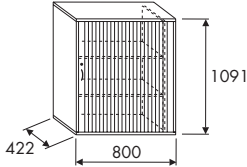
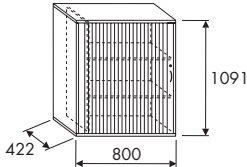
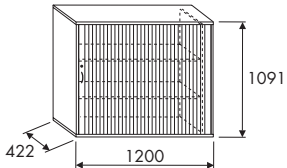
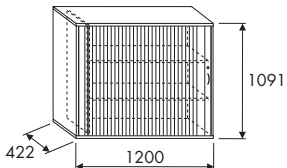
Schema	Description	Weight	Product variant	Art. No.	Price	
CABINET WITH SHUTTER DOOR width 800 mm 	Cabinet with shutter door, right-handed shutter colour finishings: - black - aluminium - one-way lock available	52,8	black	without lock	ECS10985	272,60
		52,9		with lock	ECS10985L	299,50
		52,8	aluminium	without lock	ECS10986	298,20
		52,9		with lock	ECS10986L	325,10
	Cabinet with shutter door, left-handed shutter colour finishings: - black - aluminium - one-way lock available	52,8	black	without lock	ECSL0985	272,60
		52,9		with lock	ECSL0985L	299,50
		52,8	aluminium	without lock	ECSL0986	298,20
		52,9		with lock	ECSL0986L	325,10
width 1200 mm						
	Cabinet with shutter door, right-handed shutter colour finishings: - black - aluminium - one-way lock available	72,8	black	without lock	ECS10925	340,30
		72,9		with lock	ECS10925L	367,20
		72,8	aluminium	without lock	ECS10926	364,10
		72,9		with lock	ECS10926L	391,-
	Cabinet with shutter door, left-handed shutter colour finishings: - black - aluminium - one-way lock available	72,8	black	without lock	ECSL0925	340,30
		72,9		with lock	ECSL0925L	367,20
		72,8	aluminium	without lock	ECSL0926	364,10
		72,9		with lock	ECSL0926L	391,-

Dimensions are stated in millimetres. The products weight allowance is $\pm 5\%$.

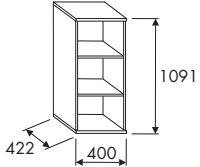
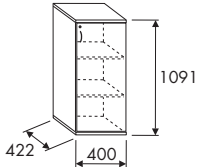
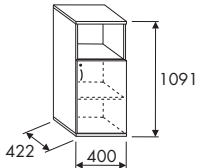
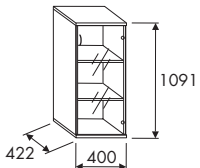
Schema	Description	Weight	Product variant	Art. No.	Price
CABINET OPEN width 400 mm		Kg			EUR
	Cabinet open with shelves	23,1		ECO1094	102,20
	CABINET WITH DOOR				
	Cabinet with door				
	- one-way lock available	28,6	without lock	ECD1094	134,80
		28,7	with lock	ECD1094L	149,-
CABINET COMBINED					
	Cabinet combined				
	- door/open element	26,6	without lock	ECDO109421	128,80
	- one-way lock available	26,7	with lock	ECDO109421L	143,-
CABINET WITH GLASS DOOR					
	Cabinet with glass door				
		28,4		ECG1094	182,30

Dimensions are stated in millimetres. The products weight allowance is ± 5%.

Schema	Description	Weight	Art. No.	Price
<p>CORNER CABINETS outer</p>	<p>Corner cabinet outer 2x shelves</p>	<p>19,1</p>	<p>ECC1094</p>	<p>152,60</p>
<p>inner</p>	<p>Corner cabinet inner 2x shelves</p>	<p>57,2</p>	<p>ECC1098</p>	<p>255,50</p>

Dimensions are stated in millimetres. The products weight allowance is ± 5%.

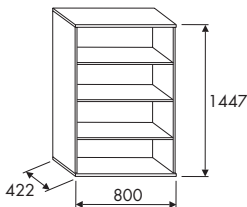
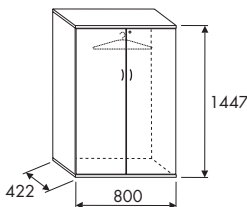
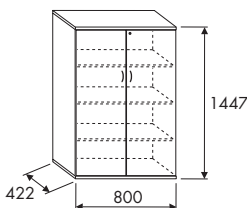
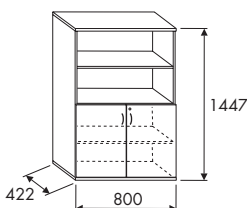
Schema	Description	Weight	Product variant	Art. No.	Price
CABINET OPEN width 800 mm		Kg			EUR
	Cabinet open with shelves	46,6		ECO1458	152,30
WARDROBE WITH DOOR					
	Wardrobe with door	49,0	without lock	ECW1458	206,40
	- equipped with an extractable bar for coat hangers - one-way lock available	49,1	with lock	ECW1458L	220,70
CABINET WITH DOOR					
	Cabinet with door	61,7	without lock	ECD1458	225,90
	- one-way lock available	61,8	with lock	ECD1458L	240,10
CABINET COMBINED					
	Cabinet combined	54,1	without lock	ECDO145822	205,50
	- door/open element - one-way lock available	54,2	with lock	ECDO145822L	219,70

Dimensions are stated in millimetres. The products weight allowance is ± 5%.

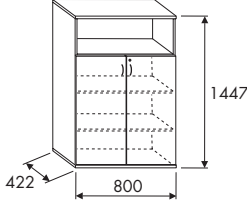
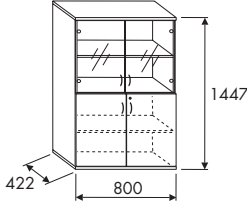
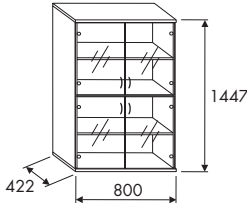
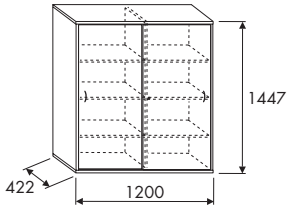
Schema	Description	Weight	Product variant	Art. No.	Price
CABINETS COMBINED width 800 mm		Kg			EUR
	Cabinet combined				
	- door/open element	57,9	without lock	ECDO145831	218,60
	- one-way lock available	58,0	with lock	ECDO145831L	232,80
	Cabinet combined				
	- door/glass door	61,4	without lock	ECDG145822	276,80
	- one-way lock available	61,5	with lock	ECDG145822L	291,-
CABINET WITH GLASS DOOR					
	Cabinet with glass door				
	glass door/glass door	61,4		ECGG145822	301,70
CABINET WITH SLIDING DOOR 1200 mm					
	Cabinet with sliding door				
	- one-way lock available	99,5	without lock	ECM1452	267,80
		99,6	with lock	ECM1452L	282,80

**HANGING FILE FRAMES
WITH THE FRONT PANELS**

Dimensions are stated in millimetres. The products weight allowance is $\pm 5\%$.

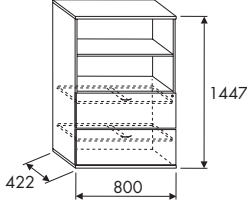
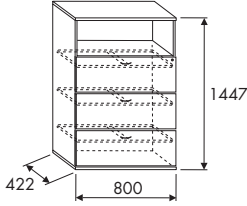
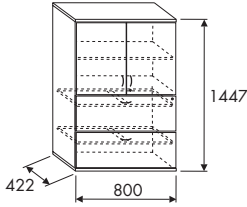
Schema	Description	Weight	Product variant	Art. No.	Price
CABINETS COMBINED		Kg			EUR
	Cabinet with hanging file frames				
	- 2 hanging file frames	61,1	without lock	ECRO145822	390,30
	- 2 open elements	61,3	with lock	ECRO145822L	429,50
	- central locking available				
	Cabinet with hanging file frames				
	- 3 hanging file frames	66,3	without lock	ECRO145831	504,40
	- open element	66,5	with lock	ECRO145831L	547,50
	- central locking available				
	Cabinet with hanging file frames				
	- 2 hanging file frames	68,6	without lock	ECRD145822	442,30
	- door	68,9	with lock	ECRD145822L	495,80
	- central locking available				
	- one-way lock available for the door				

WARNING: The hanging file frames are not equipped with the antitilt device and therefore it's necessary to secure the cabinet against possible tilt, preferably fixing it to the wall.

Dimensions are stated in millimetres. The products weight allowance is ± 5%.

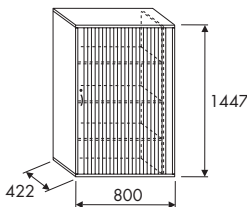
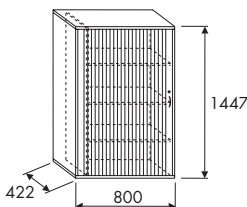
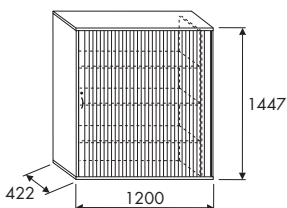
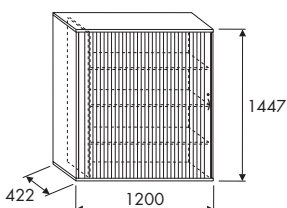
Schema	Description	Weight	Product variant		Art. No.	Price
CABINET WITH SHUTTER DOOR width 800 mm						
	Cabinet with shutter door, right-handed shutter colour finishings: - black - aluminium	67,7	black	without lock	ECS14585	342,80
		67,8		with lock	ECS14585L	369,80
	- one-way lock available	67,7	aluminium	without lock	ECS14586	380,10
		67,8		with lock	ECS14586L	407,10
	Cabinet with shutter door, left-handed shutter colour finishings: - black - aluminium	67,7	black	without lock	ECSL4585	342,80
		67,8		with lock	ECSL4585L	369,80
	- one-way lock available	67,7	aluminium	without lock	ECSL4586	380,10
		67,8		with lock	ECSL4586L	407,10
width 1200 mm						
	Cabinet with shutter door, right-handed shutter colour finishings: - black - aluminium	89,2	black	without lock	ECS14525	425,-
		89,3		with lock	ECS14525L	451,90
	- one-way lock available	89,2	aluminium	without lock	ECS14526	451,20
		89,3		with lock	ECS14526L	478,20
	Cabinet with shutter door, left-handed shutter colour finishings: - black - aluminium	89,2	black	without lock	ECSL4525	425,-
		89,3		with lock	ECSL4525L	451,90
	- one-way lock available	89,2	aluminium	without lock	ECSL4526	451,20
		89,3		with lock	ECSL4526L	478,20

Dimensions are stated in millimetres. The products weight allowance is $\pm 5\%$.

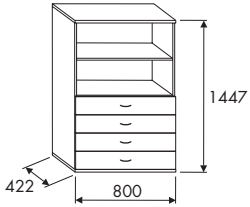
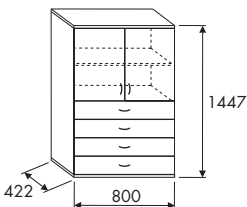
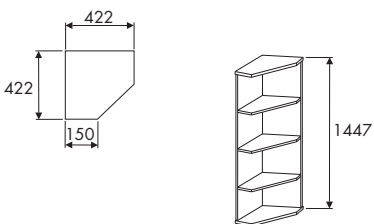
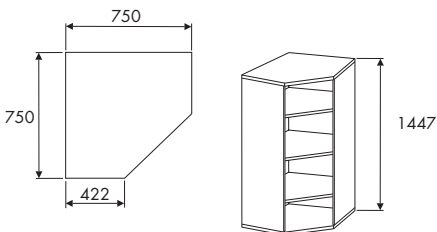
Schema	Description	Weight	Art. No.	Price
CABINETS COMBINED width 800 mm 	Cabinet combined - 4 drawers - open element	Kg 69,3	ECZO145842	340,60 EUR
	Cabinet combined - 4 drawers - door	76,8	ECZD145842	393,50
CORNER CABINETS outer	Corner cabinet outer 3x shelves	24,4	ECC1454	167,10
	inner	72,2	ECC1458	295,80
	Corner cabinet inner 3x shelves			

Dimensions are stated in millimetres. The products weight allowance is ± 5%.

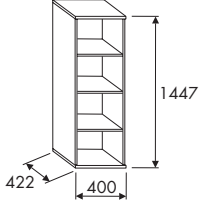
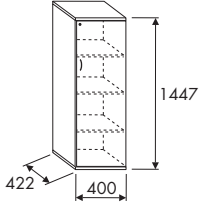
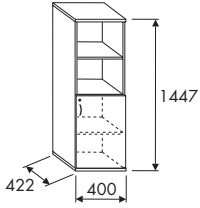
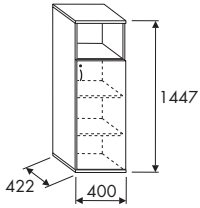
Schema	Description	Weight	Product variant	Art. No.	Price
CABINET OPEN width 400 mm		Kg			EUR
	Cabinet open with shelves	29,4		ECO1454	120,10
	CABINET WITH DOOR				
	Cabinet with door				
	- one-way lock available	36,9	without lock	ECD1454	158,-
		37,0	with lock	ECD1454L	172,20
CABINETS COMBINED					
	Cabinet combined				
	- door/open element	32,9	without lock	ECDO145422	147,20
	- one-way lock available	33,0	with lock	ECDO145422L	161,40
	Cabinet combined				
	- door/open element	35,0	without lock	ECDO145431	153,20
	- one-way lock available	35,1	with lock	ECDO145431L	167,40

Dimensions are stated in millimetres. The products weight allowance is ± 5%.

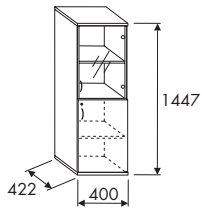
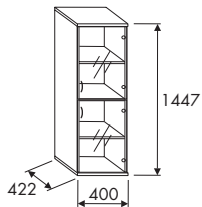
Schema	Description	Weight	Product variant	Art. No.	Price
CABINET COMBINED width 400 mm		Kg			EUR
	Cabinet combined				
	- door/glass door	36,4	without lock	ECDG145422	196,40
	- one-way lock available for lower door	36,5	with lock	ECDG145422L	210,60
CABINET WITH GLASS DOOR					
	Cabinet with glass door				
	- glass door/glass door	36,4		ECGG145422	196,90

Dimensions are stated in millimetres. The products weight allowance is $\pm 5\%$.

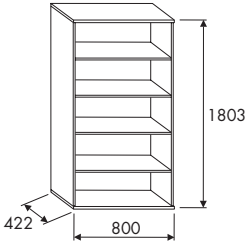
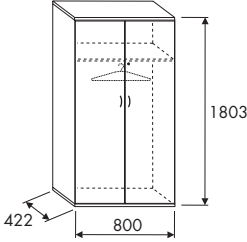
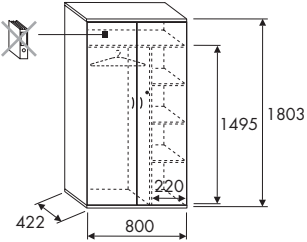
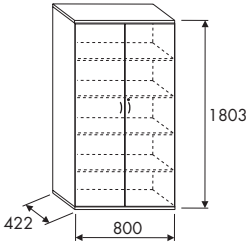
Schema	Description	Weight	Product variant	Art. No.	Price
CABINET OPEN width 800 mm		Kg			EUR
	Cabinet open with shelves	56,3		ECO1808	170,-
WARDROBES WITH DOOR					
	Wardrobe with door - equipped with an extractable bar for coat hangers - one-way lock available	63,5 63,6	without lock with lock	ECW1808 ECW1808L	237,80 252,-
	Wardrobe with door partition, shelves - equipped with an extractable bar for coat hangers - one-way lock available	74,7 74,8	without lock with lock	ECWS1808 ECWS1808L	279,70 293,90
CABINET WITH DOOR					
	Cabinet with door - one-way lock available	75,2 75,3	without lock with lock	ECD1808 ECD1808L	256,- 270,20

Dimensions are stated in millimetres. The products weight allowance is ± 5%.

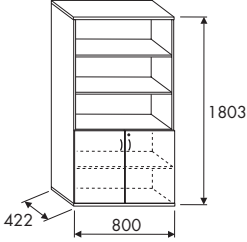
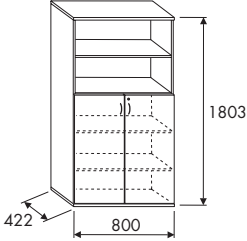
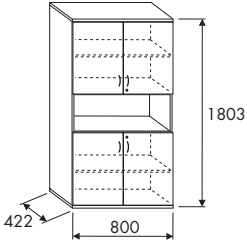
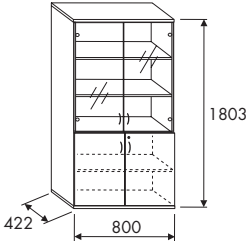
Schema	Description	Weight	Product variant	Art. No.	Price
CABINETS COMBINED		Kg			EUR
	Cabinet combined				
	- door/open element	63,9	without lock	ECDO180823	223,70
	- one-way lock available	64,0	with lock	ECDO180823L	237,90
	Cabinet combined				
	- door/open element	67,7	without lock	ECDO180832	237,90
	- one-way lock available	67,8	with lock	ECDO180832L	252,20
	Cabinet combined				
	- door/open element/ door	71,5	without lock	ECDOD1808212	271,30
	- one-way lock available	71,7	with lock	ECDOD1808212L	299,70
	Cabinet combined				
	- door/glass door	74,8	without lock	ECDG180823	311,-
	- one-way lock available	74,9	with lock	ECDG180823L	325,20

Dimensions are stated in millimetres. The products weight allowance is ± 5%.

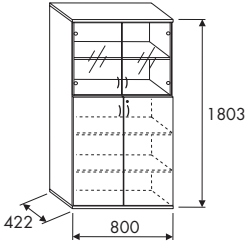
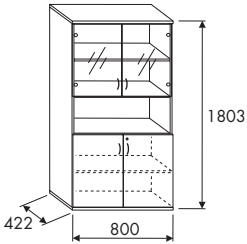
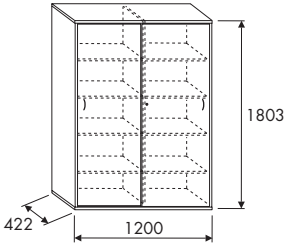
Schema	Description	Weight	Product variant	Art. No.	Price
CABINETS COMBINED					
	Cabinet combined door/glass door - one way lock available	74,8	without lock	ECDG180832	309,90
		74,9	with lock	ECDG180832L	324,10
	Cabinet combined door/open element/glass door - one way lock available	71,0	without lock	ECDG1808212	296,80
		71,1	with lock	ECDG1808212L	311,-
CABINET WITH SLIDING DOOR 1200 mm					
	Cabinet with sliding door - one-way lock available	124,5	without lock	ECM1802	367,-
		124,6	with lock	ECM1802L	382,-

Dimensions are stated in millimetres. The products weight allowance is ± 5%.

Schema	Description	Weight	Product variant	Art. No.	Price	
CABINET WITH SHUTTER DOOR width 800 mm						
	Cabinet with shutter door, right-handed shutter colour finishings: - black - aluminium	83,2	black	without lock	ECS18085	438,10
		83,3		with lock	ECS18085L	465,20
	- one-way lock available	83,2	aluminium	without lock	ECS18086	469,-
		83,3		with lock	ECS18086L	496,-
	Cabinet with shutter door, left-handed shutter colour finishings: - black - aluminium	83,2	black	without lock	ECSL8085	438,10
		83,3		with lock	ECSL8085L	465,20
	- one-way lock available	83,2	aluminium	without lock	ECSL8086	469,-
		83,3		with lock	ECSL8086L	496,-
width 1200 mm						
	Cabinet with shutter door, right-handed shutter colour finishings: - black - aluminium	110,9	black	without lock	ECS18025	481,70
		111,0		with lock	ECS18025L	508,70
	- one-way lock available	110,9	aluminium	without lock	ECS18026	519,10
		111,0		with lock	ECS18026L	546,10
	Cabinet with shutter door, left-handed shutter colour finishings: - black - aluminium	110,9	black	without lock	ECSL8025	481,70
		111,0		with lock	ECSL8025L	508,70
	- one-way lock available	110,9	aluminium	without lock	ECSL8026	519,10
		111,0		with lock	ECSL8026L	546,10

HANGING FILE FRAMES WITH THE FRONT PANELS

Dimensions are stated in millimetres. The products weight allowance is ± 5%.

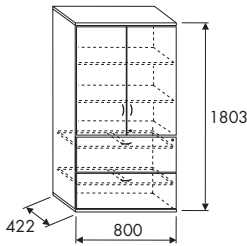
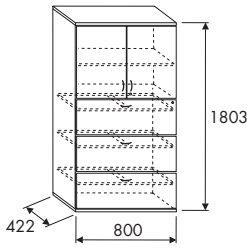
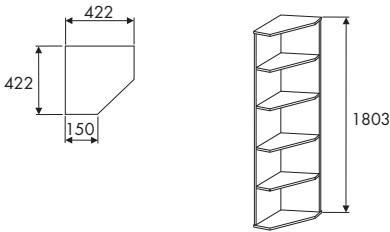
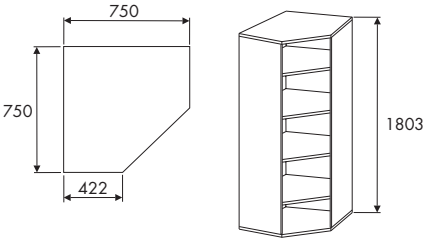
Schema	Description	Weight	Product variant	Art. No.	Price
CABINETS COMBINED					
	Cabinet combined with hanging file frames - 2 hanging file frames - door - one way lock available	81,9	without lock	ECRD180823	472,50
		82,2	with lock	ECRD180823L	526,-
	Cabinet combined with hanging file frames - 3 hanging file frames - door - one-way lock available	83,6	without lock	ECRD180832	574,20
		83,9	with lock	ECRD180832L	631,50
CORNER CABINETS					
outer					
	Corner cabinet outer 4x shelves	29,6		ECC1804	181,60
inner					
	Corner cabinet inner 4x shelves	87,1		ECC1808	333,30

WARNING: The hanging file frames are not equipped with the antitilt device and therefore it's necessary to secure the cabinet against possible tilt, preferably fixing it to the wall.

**HANGING FILE FRAMES
WITH THE FRONT PANELS**

 Dimensions are stated in millimetres. The products weight allowance is $\pm 5\%$.

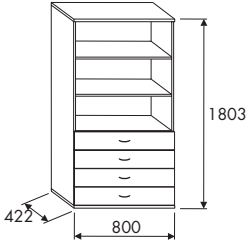
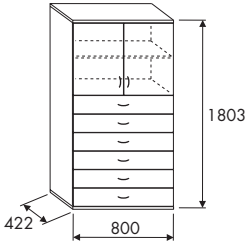
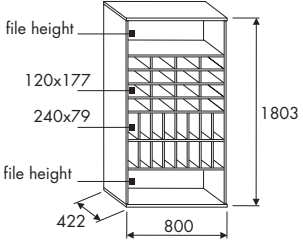
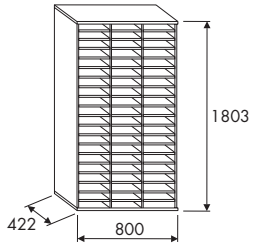
Schema	Description	Weight	Art. No.	Price
CABINETS COMBINED				
	Cabinet combined - 4 drawers - open element	79,0	ECZO180843	358,80
	Cabinet combined - 6 drawers - door	95,8	ECZD180862	518,30
CABINET FOR LETTERS AND OTHER CORRESPONDENCE				
	Cabinet for letters and other correspondence - pigeon-holes for different sizes of consignments - file shelves	98,6	ECDB1808T	366,50
	Cabinet with 60 pigeon-holes - pigeon-holes for different sizes of consignments	128,0	ECDB180860	509,60

WARNING: The hanging file frames are not equipped with the antitilt device and therefore it's necessary to secure the cabinet against possible tilt, preferably fixing it to the wall.

Dimensions are stated in millimetres. The products weight allowance is ± 5%.

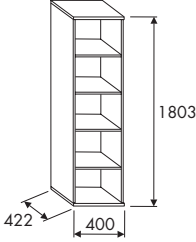
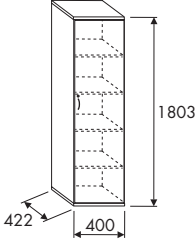
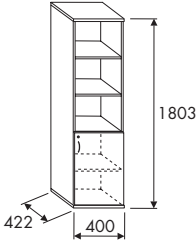
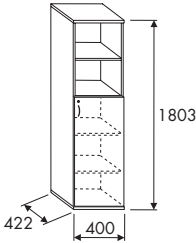
Schema	Description	Weight	Product variant	Art. No.	Price
CABINET OPEN width 400 mm		Kg			EUR
	Cabinet open with shelves	35,7		ECO1804	146,-
	CABINET WITH DOOR				
	Cabinet with door				
	- one-way lock available	45,1	without lock	ECD1804	189,20
		45,2	with lock	ECD1804L	203,40
CABINET COMBINED					
	Cabinet combined				
	- door/open element	39,2	without lock	ECDO180423	172,50
	- one-way lock available	39,3	with lock	ECDO180423L	200,-
	Cabinet combined				
	- door/open element	41,3	without lock	ECDO180432	178,60
	- one-way lock available	41,4	with lock	ECDO180432L	192,80

Dimensions are stated in millimetres. The products weight allowance is ± 5%.

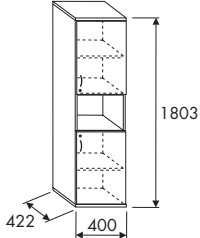
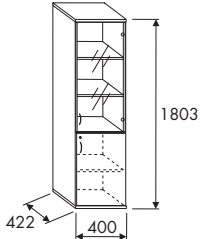
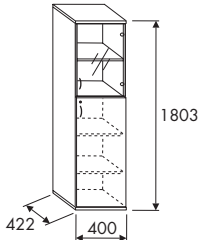
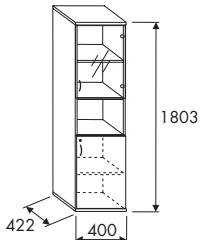
Schema	Description	Weight	Product variant	Art. No.	Price
CABINET COMBINED width 400 mm 	Cabinet combined				
	- door/open element/ door	42,7	without lock	ECDOD1804212	196,30
	- one-way lock available	42,9	with lock	ECDOD1804212L	224,80
	Cabinet combined				
	- door/glass door	44,5	without lock	ECDG180423	211,60
	- one-way lock available	44,6	with lock	ECDG180423L	225,80
	Cabinet combined				
	- door/glass door	44,5	without lock	ECDG180432	217,30
	- one-way lock available	44,6	with lock	ECDG180432L	231,50
	Cabinet combined				
	- door/open element/ glass door	42,7	without lock	ECDOG1804212	211,30
	- one-way lock available	42,8	with lock	ECDOG1804212L	225,50

Dimensions are stated in millimetres. The products weight allowance is ± 5%.

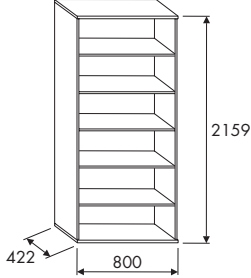
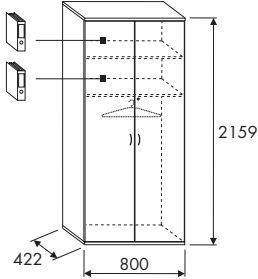
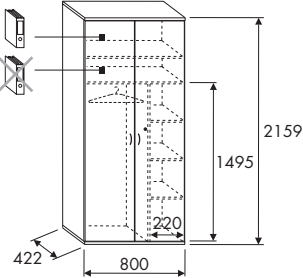
Schema	Description	Weight	Product variant	Art. No.	Price
<p>CABINET OPEN width 800 mm</p> 	Cabinet open with shelves	66,2		ECO2158	232,50
<p>WARDROBE WITH DOOR</p> 	Wardrobe with door - equipped with an extractable bar for coat hangers - one-way lock available	76,6 76,7	without lock with lock	ECW2158 ECW2158L	291,30 305,50
	Wardrobe with door partition, shelves - equipped with an extractable bar for coat hangers - one-way lock available	87,8 87,9	without lock with lock	ECWS2158 ECWS2158L	334,60 348,80

Dimensions are stated in millimetres. The products weight allowance is ± 5%.

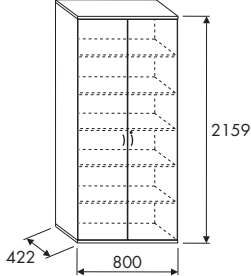
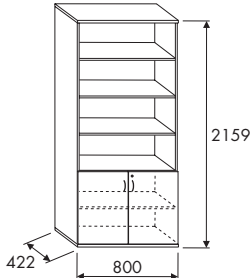
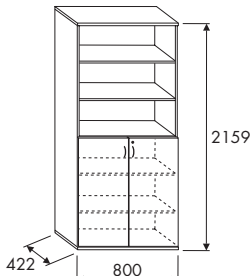
Schema	Description	Weight	Product variant	Art. No.	Price
CABINET WITH DOOR		Kg			EUR
	Cabinet with door				
	- one-way lock available	88,9	without lock	ECD2158	326,50
		89,0	with lock	ECD2158L	340,70
CABINET COMBINED					
	Cabinet combined				
	- door/open element				
	- one-way lock available	73,8	without lock	ECDO215824	285,70
		73,9	with lock	ECDO215824L	299,90
	Cabinet combined				
	- door/open element				
	- one-way lock available	77,5	without lock	ECDO215833	298,30
		77,6	with lock	ECDO215833L	312,50

Dimensions are stated in millimetres. The products weight allowance is ± 5%.

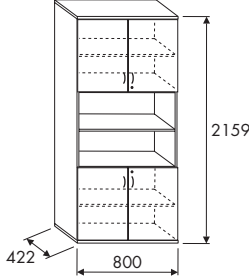
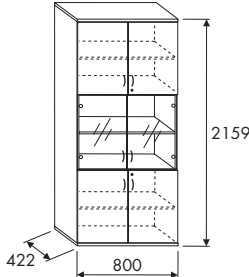
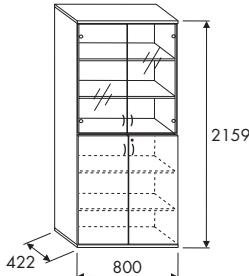
Schema	Description	Weight	Product variant	Art. No.	Price
CABINET COMBINED		Kg			EUR
	Cabinet combined				
	- door/open element/ door				
	- one-way lock available	81,3	without lock	ECDOD2158222	333,30
		81,4	with lock	ECDOD2158222L	361,70
	Cabinet combined				
	- door/glass door/ door				
	- one-way lock available	94,8	without lock	ECDGD2158222	406,20
		95,0	with lock	ECDGD2158222L	434,80
	Cabinet combined				
	- door/glass door				
	- one-way lock available	88,5	without lock	ECDG2158333	384,30
		88,6	with lock	ECDG2158333L	398,60

Dimension are stated in millimetres. The products weight allowance is $\pm 5\%$.

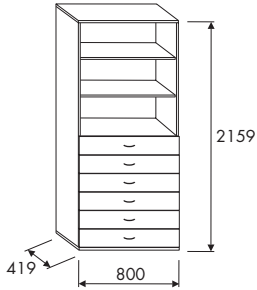
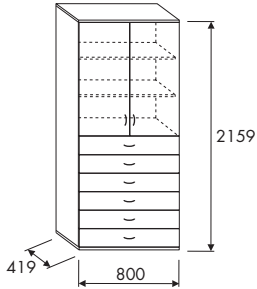
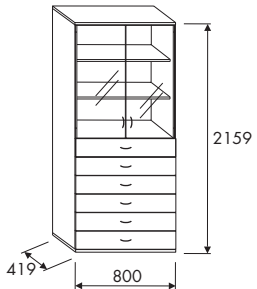
Schema	Description	Weight	Product variant	Art. No.	Price
CABINETS COMBINED		Kg			EUR
	Cabinet combined 6 drawers/ open element	98,2	without lock	ECZO215863	518,30
	Cabinet combined 6 drawers/door	109,5	without lock	ECZD215863	581,10
	Cabinet combined 6 drawers/ glass door	109,2	without lock	ECZG215863	605,-

Dimensions are stated in millimetres. The products weight allowance is ± 5%.

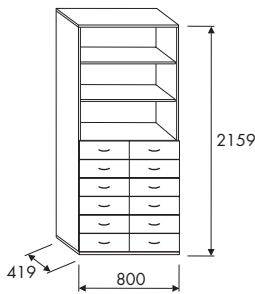
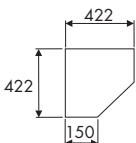
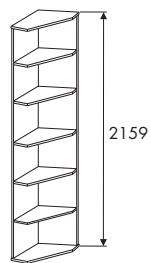
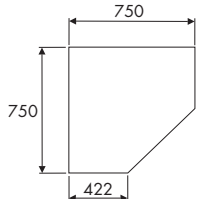
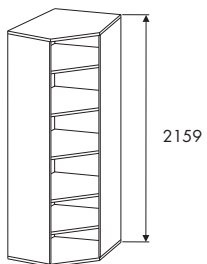
Schema	Description	Weight	Product variant	Art. No.	Price
CABINET COMBINED		Kg			EUR
	Cabinet combined 12 drawers/ open element	109,3	without lock	ECZO2158123	738,40
CORNER CABINETS	outer				
 	Corner cabinet outer 5 shelves	34,8		ECC2154	194,30
	inner				
 	Corner cabinet outer 5 shelves	102,2		ECC2158	366,-

**HANGING FILE FRAMES
WITH THE FRONT PANELS**

Dimensions are stated in millimetres. The products weight allowance is ± 5%.

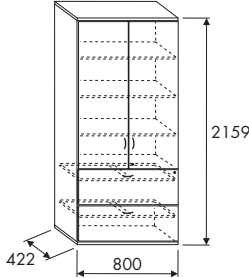
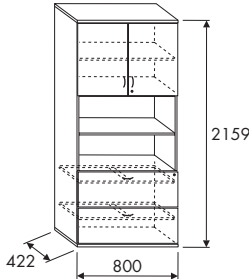
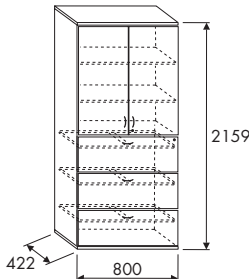
Schema	Description	Weight	Product variant	Art. No.	Price
CABINET COMBINED		Kg			EUR
	Cabinet with hanging file frames				
	- 2 hanging file frames - door	95,8	without lock	ECRD215824	544,-
	- central locking available - one-way lock available for the door	96,1	with lock	ECRD215824L	597,50
	Cabinet with hanging file frames				
	- 2 hanging file frames - open element - door	88,0	without lock	ECROD2158222	522,50
	- central locking available - one-way lock available for the door	88,3	with lock	ECROD2158222L	575,90
	Cabinet with hanging file frames				
	- 3 hanging file frames - door	97,2	without lock	ECRD215833	658,50
	- central locking available - one-way lock available for the door	97,5	with lock	ECRD215833L	706,50

WARNING: The hanging file frames are not equipped with the antitilt device and therefore it's necessary to secure the cabinet against possible tilt, preferably fixing it to the wall.

**HANGING FILE FRAMES
WITH THE FRONT PANELS**

Dimensions are stated in millimetres. The products weight allowance is ± 5%.

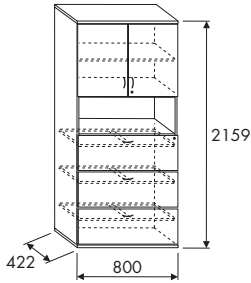
Schema	Description	Weight	Product variant	Art. No.	Price
	Cabinet with hanging file frames				EUR
	- 3 hanging file frames	93,5	without lock	ECROD2158312	636,70
	- open element - door	93,8	with lock	ECROD2158312L	693,90
	- central locking available - one-way lock available for the door				

WARNING: The hanging file frames are not equipped with the antitilt device and therefore it's necessary to secure the cabinet against possible tilt, preferably fixing it to the wall.

Dimensions are stated in millimetres. The products weight allowance is ± 5%.

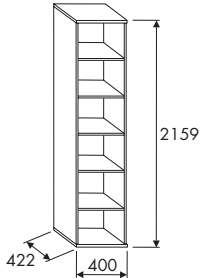
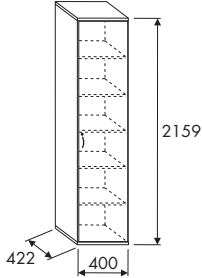
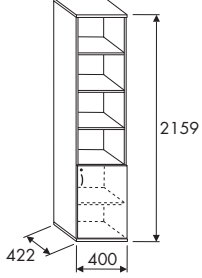
Schema	Description	Weight	Product variant	Art. No.	Price
CABINET OPEN width 400 mm 	Cabinet open with shelves	Kg			EUR
		42,1		ECO2154	163,80
CABINET WITH DOOR 	Cabinet with door - one-way lock available	53,3	without lock	ECD2154	209,60
		53,4	with lock	ECD2154L	223,80
CABINET COMBINED 	Cabinet combined - door/open element - one-way lock available	45,6	without lock	ECDO215424	189,20
		45,7	with lock	ECDO215424L	203,40

Dimensions are stated in millimetres. The products weight allowance is ± 5%.

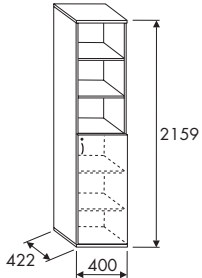
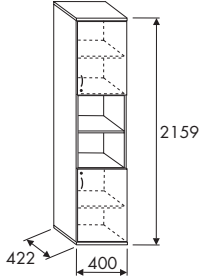
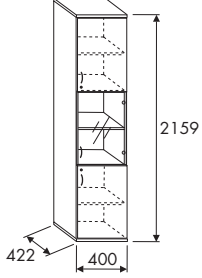
Schema	Description	Weight	Product variant	Art. No.	Price
CABINET COMBINED width 400 mm 	Cabinet combined				
	- door/open element				
	- one-way lock available	47,6	without lock	ECDO215433	195,20
		47,7	with lock	ECDO215433L	209,40
	Cabinet combined				
	- door/open element/ door				
	- one-way lock available	49,1	without lock	ECDOD2154222	213,50
		49,3	with lock	ECDOD2154222L	242,-
	Cabinet combined				
	- door/glass door/ door				
	- one-way lock available	52,6	without lock	ECDGD2154222	251,20
		52,8	with lock	ECDGD2154222L	279,60

Dimensions are stated in millimetres. The products weight allowance is $\pm 5\%$.

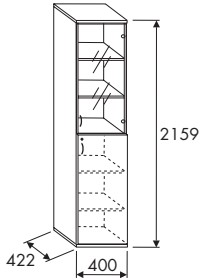
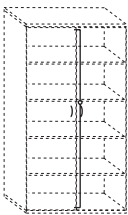
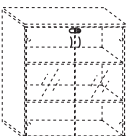
Schema	Description	Weight	Product variant	Art. No.	Price
CABINET COMBINED		Kg			EUR
	Cabinet combined				
	- door/glass door				
	- one-way lock available	53,3	without lock	ECDG215433	239,40
		53,4	with lock	ECDG215433L	253,60
TWO-WAY LOCK					
	Two-way lock locking the door to the bottom and the top of the carcass	0,5		LCD2	30,70
<p>Notice: To be used as accessory for cabinets without any lock. Has to be ordered simultaneously with the cabinet, it's not possible to install the lock additionally.</p>					
LOCK FOR GLASS DOOR					
	Lock for glass door				
	- one-way locking	0,2		LCG	27,50
<p>Notice: To be used as accessory for cabinets without any lock. Has to be ordered simultaneously with the cabinet, it's not possible to install the lock additionally.</p>					

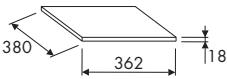
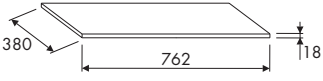
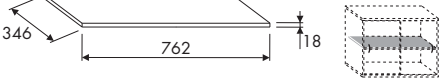
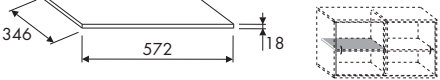
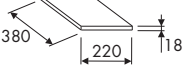
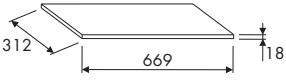

Dimensions are stated in millimetres. The products weight allowance is $\pm 5\%$.

Schema	Description	Weight	Product variant	Art. No.	Price
to be used for cabinets "ECO", "ECD" and combined					
 <p>width 400 mm</p>	Additional shelf for cabinets width 400 mm: - open - with door - combined, including connecting fittings	2,2	additional shelf	ESW04F4	9,10
		2,2	fixed shelf	ESW04M4	12,-
 <p>width 800 mm</p>	Additional shelf for cabinets width 800 mm: - open - with door - combined - with hanging file frames, including connecting fittings	3,9	additional shelf	ESW08F4	13,-
		3,9	fixed shelf	ESW08M4	16,-
to be used for cabinets "ECM"					
 <p>width 800 mm</p>	Additional shelf for cabinets width 800 mm: - with sliding door, including connecting fittings	4,1	additional shelf	ESWM08F4	13,-
		4,1	fixed shelf	ESWM08M4	16,-
 <p>width 1200 mm</p>	Additional shelf for cabinets width 1200 mm: - with sliding door, including connecting fittings	2,8	additional shelf	ESWM12F4	11,40
		2,8	fixed shelf	ESWM12M4	14,30
to be used for cabinets "ECWS"					
 <p>width 220 mm</p>	Additional shelf for wardrobe with a partition, including the shelf stabilizers	1,2	additional shelf	ESWS02F4	8,30
to be used for cabinets "ECS"					
 <p>width 800 mm</p>	Additional shelf for cabinets width 800 mm, including connecting fittings	2,9	additional shelf	ESW06F4	12,80
		2,9	fixed shelf	ESW06M4	15,70

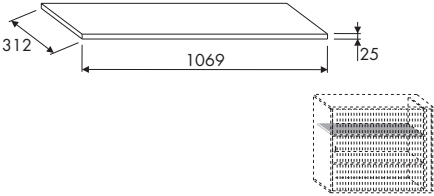
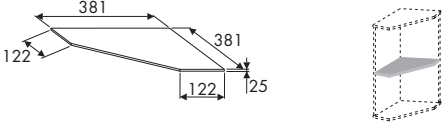
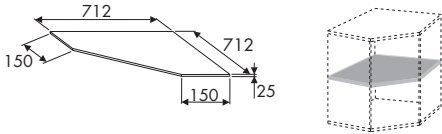
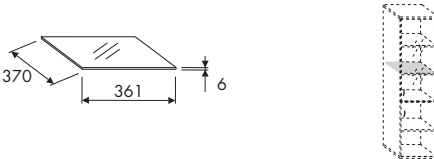
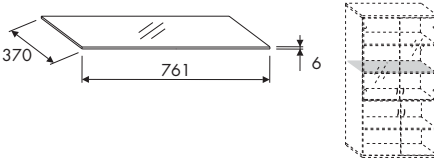
Dimensions are stated in millimetres. The products weight allowance is $\pm 5\%$.

Schema	Description	Weight	Product variant	Art. No.	Price
to be used for cabinets "ECS"					
<p>width 1200 mm</p> 	<p>Additional shelf for cabinets with shutter door width 1200 mm,</p> <p>- including connecting fittings</p>	4,6	additional shelf	ESW10F4	16,70
		4,6	fixed shelf	ESW10M4	19,60
to be used for cabinets "ECC"					
<p>width 422 mm</p> 	<p>Additional shelf for corner outer cabinets</p> <p>- including connecting fittings</p>	1,5	additional shelf	ESWC04F4	24,60
		1,5	fixed shelf	ESWC04M4	27,-
<p>width 750 mm</p> 	<p>Additional shelf for corner inner cabinets</p> <p>- including connecting fittings</p>	6,1	additional shelf	ESWC07F4	45,30
		6,1	fixed shelf	ESWC07M4	52,-
to be used for cabinets "ECO", "ECG" and combined					
<p>width 400 mm</p> 	<p>Glass shelf for cabinets width 400 mm,</p> <p>- including connecting fittings</p>	2,2	additional shelf	ESG04F4	15,70
<p>width 800 mm</p> 	<p>Glass shelf for cabinets width 800 mm,</p> <p>- including connecting fittings</p>	3,9	additional shelf	ESG08F4	28,20

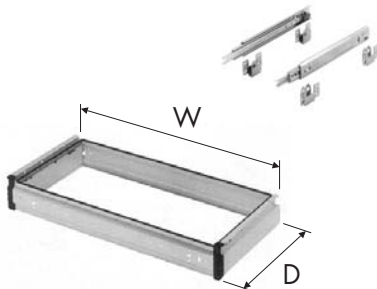
Dimensions are stated in millimetres. The products weight allowance is $\pm 5\%$.

Schema	Description	Weight	Dimensions		Product variant	Art. No.	Price
			W	D			
HANGING FILE FRAME							
	Hanging file frame including 1 set of runners						
	Frame in colour finishing black RAL 9005 FOR CABINETS: - open "ECO", "SCO" - with door "ECD", "SCD"... - combined "ECDO", "SCDO"...	5,5	762	380	without installing	TF0804	81,70
		5,5	762	380	installing in our production	TFM0804	94,50
Note: Hanging file frame has to be ordered together with the product.							
CROSS BAR							
	Cross bar for hanging file frame Cross bar in colour finishing black RAL 9005	0,1				TFC04	5,40

Note: Hanging file frames are used as accessory for cabinets type Economic and Standard.



Hanging file frames

- enabling additional installing in our cabinets
- possible installation in our production (max. 3 hanging file frames in 1 cabinet)

Possibility of lengthwise or crosswise hanging the files



Information/warning max. number of used hanging file frames and fixing the cabinet to the wall (stick-on label)

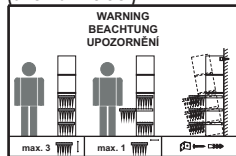

▼ Safety plastic corners



▼ Bull runners with 100% extension



WARNING:

The hanging file frames are not equipped with the antitilt device and therefore it's necessary to secure the cabinet against possible tilt, preferably fixing it to the wall.

MELAMINE FURNITURE
COLOUR FINISHINGS
 DESK THICKNESS 18 mm

CARCASS COLOUR FINISHINGS

STANDARD COLOUR FINISHING

Delivery term of furniture in standard colour finishing is four weeks

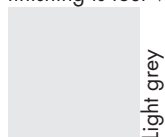

ADDITIONAL COLOUR FINISHING

Delivery term of furniture in additional colour finishing is six weeks or by agreement with the seller.



Furniture line Economic contains only basic types of pedestals.

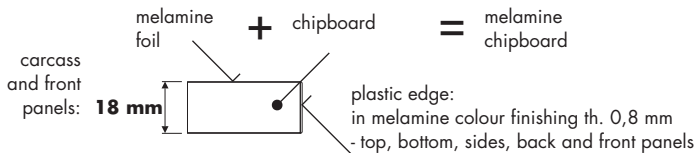

DOOR COLOUR FINISHINGS

STANDARD COLOUR FINISHINGS

Delivery term of furniture in standard colour finishings is four weeks.



ADDITIONAL COLOUR FINISHINGS

Delivery term of furniture in additional colour finishings is six weeks or by agreement with the seller.

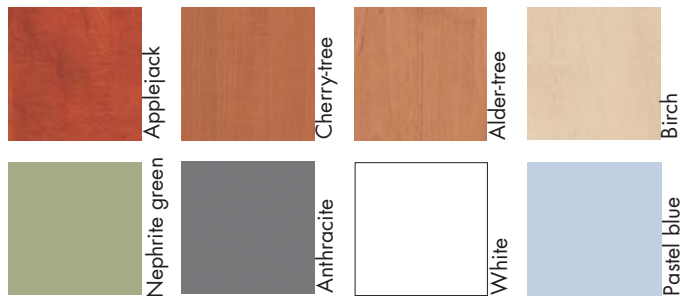

ACCESSORY

PLASTIC PEN TRAY TO BE USED FOR ALL TYPES OF PEDESTALS

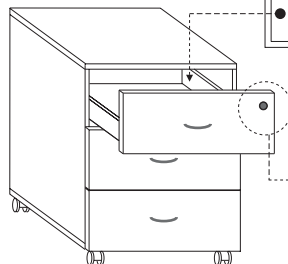
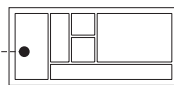

Dimensions are stated in millimetres. The products weight allowance is $\pm 5\%$.

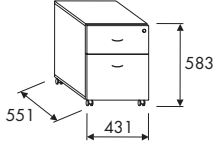
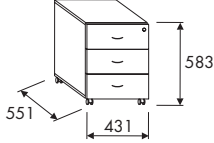
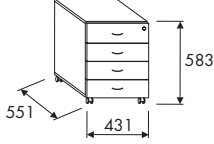
Schema	Description	Weight	Art. No.	Price
MOBILE		Kg		EUR
	Mobile pedestal equipped with central locking - drawer - file drawer	25,5	SXM2	149,40
	Mobile pedestal equipped with central locking - 3 drawers	26,5	SXM3	152,80
	Mobile pedestal equipped with central locking - 4 drawers	27,9	SXM4	163,-

**MELAMINE FURNITURE
COLOUR FINISHINGS**

FOR THICKNESS:

- 18 mm
- 25 mm

sides, front panels
and backs: 18 mm
top, bottom: 25 mm

melamine foil + chipboard = melamine chipboard

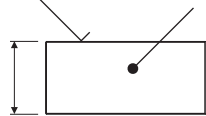

plastic edge:
in melamine colour
finishings or in the multiplex
th. 0,8 mm - sides and front panels
th. 2 mm - top and bottom



STANDARD COLOUR FINISHINGS

Delivery term of furniture in standard colour finishings is four weeks.



ADDITIONAL COLOUR FINISHINGS

Delivery term of furniture in additional colour finishings is six weeks or by agreement with the seller.



FRONT PANELS ADDITIONAL COLOUR FINISHINGS



Desk height pedestals
- depth 600 and 800 mm
- equipped with arresting elements for floor levelling



Metal rounded handles in colour finishing silver or black

ACCESSORY

PLASTIC PEN TRAY
TO BE USED FOR ALL
TYPES OF PEDESTALS

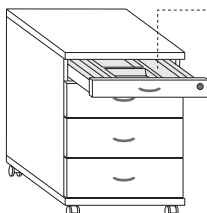
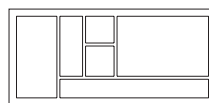

Top drawer
- individual pen tray

75% extension
of drawers



Mobile pedestals
- equipped with
antilift device

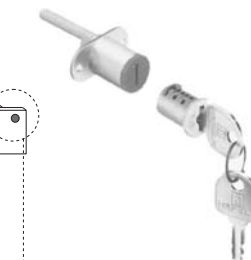
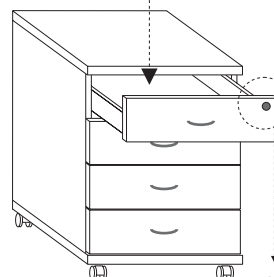

Häfele locks
enabling the system
of general key

Dimensions are stated in millimetres. The products weight allowance is $\pm 5\%$.

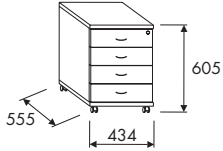
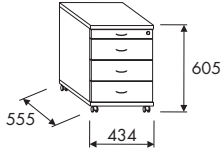
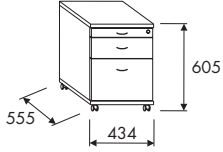
Schema	Description	Weight	Art. No.	Price
MOBILE		Kg		EUR
	Mobile pedestal equipped with central locking - 4 drawers	30,8	EXM9554	209,60
	Mobile pedestal equipped with central locking - 3 drawers - pen drawer	30,4	EXM0553	219,-
	Mobile pedestal equipped with central locking - pen drawer - drawer - file drawer	29,7	EXM0552	211,80

Dimensions are stated in millimetres. The products weight allowance is $\pm 5\%$.

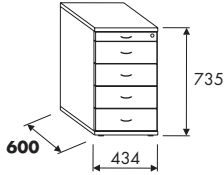
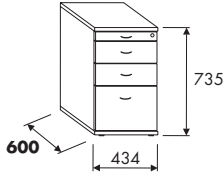
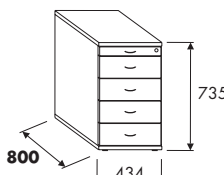
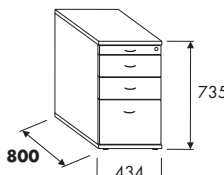
Schema	Description	Weight	Art. No.	Price
DESK HEIGHT		Kg		EUR
	Desk height pedestal equipped with central locking - pen drawer - 4 drawers	37,4	EXS0604	232,10
	Desk height pedestal equipped with central locking - pen drawer - 2 drawers - file drawer	36,5	EXS0603	237,-
	Desk height pedestal equipped with central locking - pen drawer - 4 drawers	44,8	EXS0804	241,70
	Desk height pedestal equipped with central locking - pen drawer - 2 drawers - file drawer	43,9	EXS0803	246,60

Dimensions are stated in millimetres. The products weight allowance is $\pm 5\%$.

Schema	Description	Weight	Depth	Partition	Art. No.	Price
DESK HEIGHT		Kg	mm	wall		EUR
	Desk height pedestal for tables with a partition wall	37,6	618	Panel	EXS1604	232,10
	- central locking - pen tray - 4 drawers	37,7	622	Fabric	EXS2604	232,10
	Desk height pedestal for tables with a partition wall	36,7	618	Panel	EXS1603	237,-
	- central locking - pen tray - 2 drawers - file drawer	36,8	622	Fabric	EXS2603	237,-
	Desk height pedestal for tables with a partition wall	45,0	818	Panel	EXS1804	241,70
	- central locking - pen tray - 4 drawers	45,1	822	Fabric	EXS2804	241,70
	Desk height pedestal for tables with a partition wall	44,1	818	Panel	EXS1803	246,60
	- central locking - pen tray - 2 drawers - file drawer	44,2	822	Fabric	EXS2803	246,60

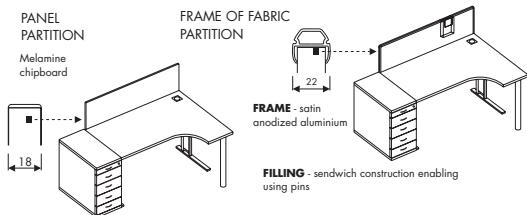

Dimensions are stated in millimetres. The products weight allowance is $\pm 5\%$.

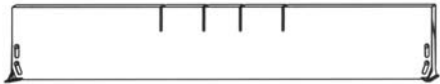
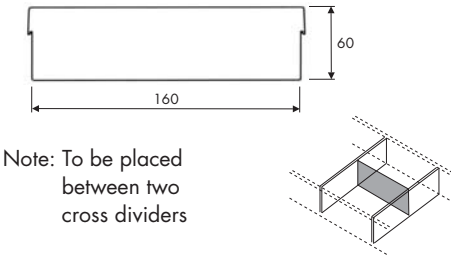
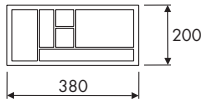
Schema	Description	Weight	Colour	Art. No.	Price
DRAWER DIVIDER - CROSS		Kg			EUR
	Drawer divider - cross Enabling classification of the drawer	0,29	black RAL 9005	MDDT5	4,40
DRAWER DIVIDER - LONGITUDINAL					
 <p>Note: To be placed between two cross dividers</p>	Drawer divider longitudinal Enabling classification of the drawer - to be used only with the cross divider	0,1	black RAL 9005	MDDL5	1,30
PLASTIC PEN TRAY					
	Plastic pen tray To be inserted on the bottom of the drawer	0,2	black	PT-A	5,50

"UNIVERSAL"

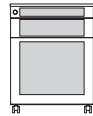
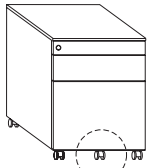

CENTRAL LOCKING

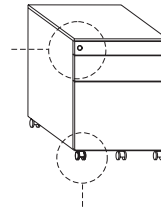

Baked powder coating

Metal sheet

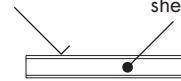

CARCASS COLOUR
ALUMINIUM RAL 9006

DRAWERS COLOUR
BLACK RAL 9005



FILE DRAWER
THIRD CASTOR
AS ANTITILT
DEVICE

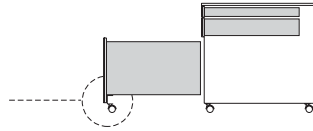

CASTORS
- ROTARY
- BLACK PLASTIC

"PROFESSIONAL"

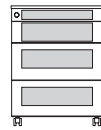
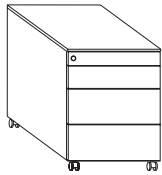

PEDESTALS PROFESSIONAL
EQUIPPED WITH THE ANTITILT
DEVICE



Antitilt device

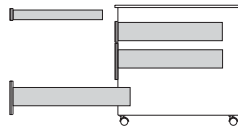

CERTIFICATE

PEDESTALS PROFESSIONAL ARE CERTIFIED "GEPRÜFTE SICHERHEIT" MAXIMUM LOAD 15 kg

"UNIVERSAL CALL CENTER"

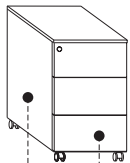

DRAWERS COLOUR
BLACK RAL 9005

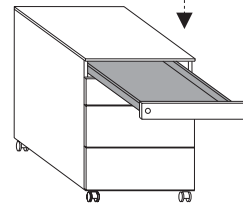

ACCESSORIES
INSERTED PLASTIC
PEN TRY FOR ALL
TYPES OF PEDESTAL

**CARCASS AND FRONT
PANELS COLOUR**
ALUMINIUM RAL 9006

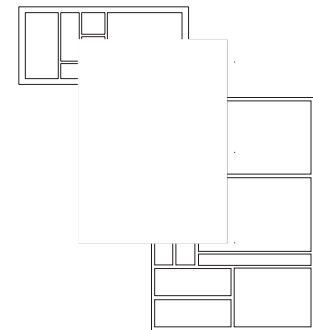
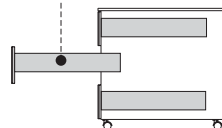

Dimensions are stated in millimetres. The products weight allowance is $\pm 5\%$.

Schema	Description	Weight	Colour	Art. No.	Price
<p>"UNIVERSAL"</p> <p>MOBILE</p>	<p>DEPTH 533 mm</p> <p>Metal pedestal mobile with central locking</p> <p>- 1 pen drawer - 1 drawer - 1 file drawer</p>	<p>Kg</p> <p>22,5 22,5</p>	<p>anthracite aluminium</p>	<p>MXM0582N MXM0582A</p>	<p>303,40 303,40</p> <p>EUR</p>
	<p>Metal pedestal mobile with central locking</p> <p>- 1 pen drawer - 3 drawers</p>	<p>22,0 22,0</p>	<p>anthracite aluminium</p>	<p>MXM0583N MXM0583A</p>	<p>299,60 299,60</p>
	<p>Metal pedestal mobile with central locking</p> <p>- 1 drawer - 1 file drawer</p>	<p>19,0 19,0</p>	<p>anthracite aluminium</p>	<p>MXM9582N MXM9582A</p>	<p>269,60 269,60</p>
	<p>Metal pedestal mobile with central locking</p> <p>- 3 drawers</p>	<p>19,0 19,0</p>	<p>anthracite aluminium</p>	<p>MXM9583N MXM9583A</p>	<p>267,10 267,10</p>

Dimensions are stated in millimetres. The products weight allowance is $\pm 5\%$.

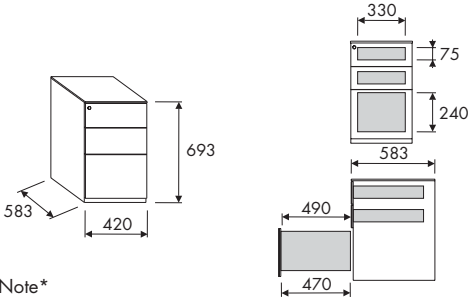
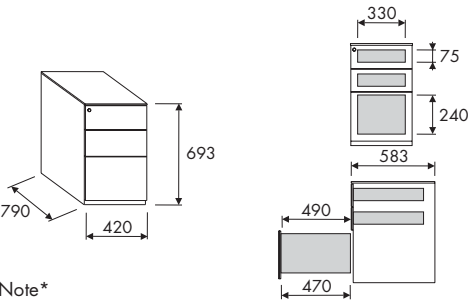
Schema	Description	Weight	Colour	Art. No.	Price
<p>"UNIVERSAL"</p> <p>DESK-HEIGHT</p>  <p>Note*</p>	<p>Desk height metal pedestal with central locking</p> <p>- 2 drawers</p> <p>- file drawer</p>	<p>Kg</p> <p>36,5</p> <p>36,5</p>	<p>anthracite</p> <p>aluminium</p>	<p>MXS9603N</p> <p>MXS9603A</p>	<p>387,50</p> <p>387,50</p>
	<p>Desk height metal pedestal with central locking</p> <p>- 4 drawers</p>	<p>34,4</p> <p>34,4</p>	<p>anthracite</p> <p>aluminium</p>	<p>MXS9604N</p> <p>MXS9604A</p>	<p>387,50</p> <p>387,50</p>
DEPTH 790 mm					
 <p>Note*</p>	<p>Desk height metal pedestal with central locking</p> <p>- 2 drawers</p> <p>- file drawer</p>	<p>43,0</p> <p>43,0</p>	<p>anthracite</p> <p>aluminium</p>	<p>MXS9793N</p> <p>MXS9793A</p>	<p>414,60</p> <p>414,60</p>

* - when using desk height pedestals together with BASIC and SIMPLE desks, the wooden top is highly recommended.

Dimensions are stated in millimetres. The products weight allowance is $\pm 5\%$.

Schema	Description	Weight	Colour	Art. No.	Price
"PROFESSIONAL"	DEPTH 781 mm	Kg			EUR
	Metal pedestal mobile with central locking - pen drawer - 1 drawer - file drawer	41,0	aluminium	MXM0792A	514,60
	Metal pedestal mobile with central locking and antitilt device - pen drawer - 3 drawers	42,0	aluminium	MXM0793A	501,30

Dimensions are stated in millimetres. The products weight allowance is $\pm 5\%$.

Schema	Description	Weight	Colour	Art. No.	Price
<p>"UNIVERSAL CALL CENTER" MOBILE</p>	<p>DEPTH 533 mm</p> <p>Metal pedestal mobile with central locking</p> <p>- 1 drawer - file drawer</p>	<p>Kg</p> <p>18,3</p>	aluminium	MXM9532A	269,60
	<p>Metal pedestal mobile with central locking</p> <p>- 3 drawers</p>	<p>18,2</p>	aluminium	MXM9533A	267,10
<p>DESK-HEIGHT</p>	<p>DEPTH 583 mm</p> <p>Desk height metal pedestal with central locking</p> <p>- 2 drawers - file drawer</p>	<p>31,0</p>	aluminium	MXS9633A	387,50

Note*

* - when using desk height pedestals together with BASIC and SIMPLE desks, the wooden top is highly recommended.

Dimensions are stated in millimetres. The product weight allowance is $\pm 5\%$.

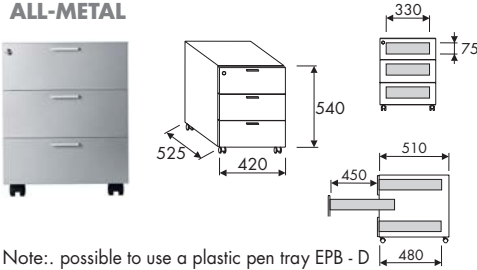
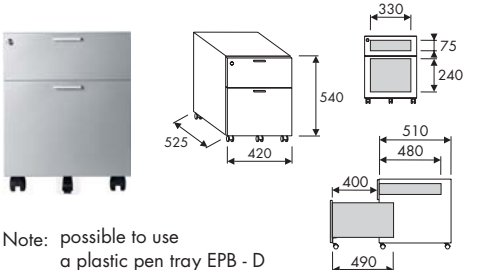
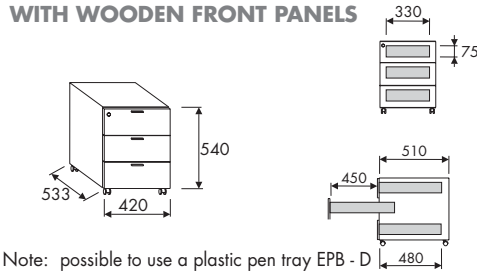
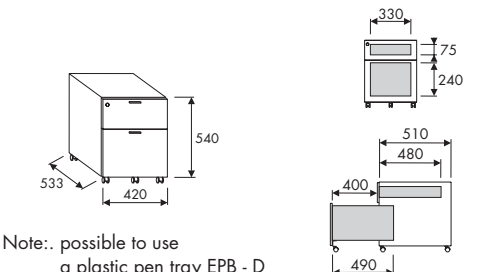
Schema	Description	Weight	Colour finishing	Art. No.	Price
<p>PEDESTALS "MXM" MOBILE</p> <p>ALL-METAL</p>  <p>Note: possible to use a plastic pen tray EPB - D</p>	<p>Metal pedestal mobile with central locking</p> <p>- 3 drawers</p>	18,2	aluminium RAL9006	MXM3A	152,80
 <p>Note: possible to use a plastic pen tray EPB - D</p>	<p>Metal pedestal mobile with central locking</p> <p>- drawer</p> <p>- file drawer</p>	18,2	aluminium RAL9006	MXM2A	152,80
<p>PEDESTALS "MXM" MOBILE</p> <p>WITH WOODEN FRONT PANELS</p>  <p>Note: possible to use a plastic pen tray EPB - D</p>	<p>Metal pedestal mobile with wooden front panels and central locking</p> <p>- 3 drawers</p>	20,0	aluminium RAL9006	MXMD3A	178,90
 <p>Note: possible to use a plastic pen tray EPB - D</p>	<p>Metal pedestal mobile with wooden front panels and central locking</p> <p>- drawer</p> <p>- file drawer</p>	20,0	aluminium RAL9006	MXMD2A	180,20

Dimensions are stated in millimetres. The products weight allowance is $\pm 5\%$.

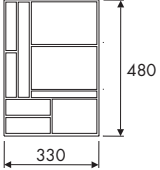
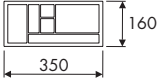
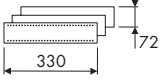
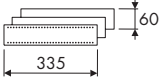
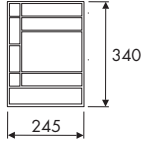
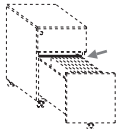
Schema	Description	Weight	Package	Colour	Art. No.	Price
"UNIVERSAL"						
	Plastic pen tray	0,15	1 pcs	black	EPB-C	17,50
	It is inserted on the bottom of the drawer.					
	Plastic pen tray	0,1	1 pcs	black	EPB-D	8,80
	It is inserted on the corpus of the drawer					
 <p>1 set = 3 pcs</p>	Metal drawer divider - cross	0,21	1 set	black	VS03	21,30
	To be inserted into the corpus of the drawer					
 <p>1 set = 3 pcs</p>	Metal drawer dividers - cross	0,2	1 set	black	VS03P	21,30
	To be inserted into the corpus of the drawer					
"UNIVERSAL CALL CENTER"						
	Plastic pen tray big	0,1	1 pcs	black	EPB-E	11,70
	To be inserted on the bottom of the drawer					
	Crossbar	0,1	1 pcs		ASM341	10,90
	To be put into file drawer					

Dimensions are stated in millimetres. The products weight allowance is $\pm 5\%$.

Schema	Description	Weight	Price	Art. No.	Price
"UNIVERSAL"		Kg	category		EUR
<p>The wooden tops are offered in accordance with desks worktop.</p>	Wooden top for desk height pedestal for desk depth 600 mm	4,8	S	EB0426	17,30
		4,8	L	EBL0426	25,80
<p>The wooden tops are offered in accordance with desks worktop.</p>	Wooden top for desk height pedestal for desk depth 800 mm	6,3	S	EB0428	21,70
		6,3	L	EBL0428	32,80
"UNIVERSAL CALL CENTER"					
<p>The wooden tops are offered in accordance with desks worktop.</p>	Wooden top for desk height pedestal for desk depth 600 mm	3,6	S	EB0326	16,50
		3,6	L	EBL0326	23,30

Price category **S**: STANDARD colour finishings

Price category **L**: ADDITIONAL colour finishings

