

2009

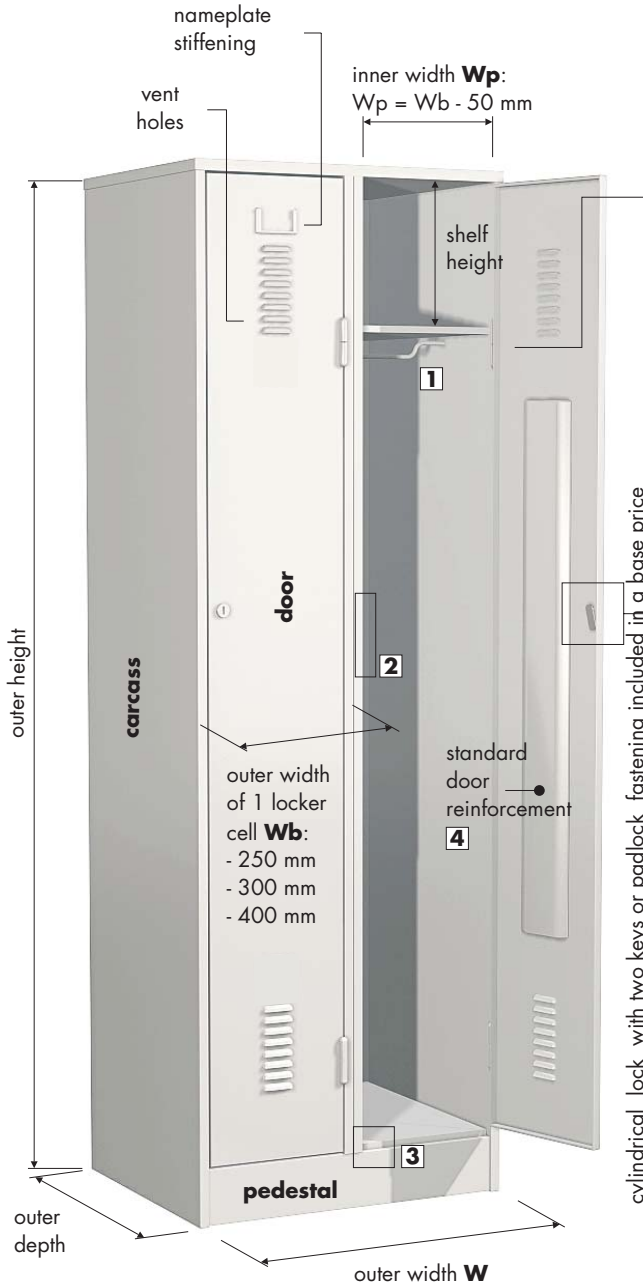

METAL LOCKERS
LOCKERS

LOCKERS



1
Lockers are
standardly
equipped
with bar
for coat hangers,
3 plastic hooks



2
Lock reinforcement
(surcharge)



cylindrical
lock +
2x

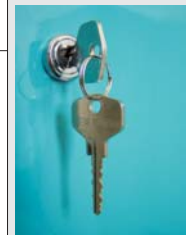

padlock
fastening
(padlock not incl.)



three-way
lock
(surcharge)



3
Softening silicone
lenses



standard
door
reinforcement

4
door
reinforcement
(surcharge)

cylindrical lock with two keys or padlock fastening included in a base price

Presented material colours are only orientational and depend on the quality of printing.

TECHNICAL SPECIFICATION

materials

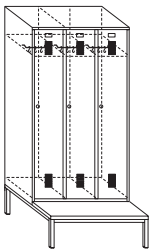
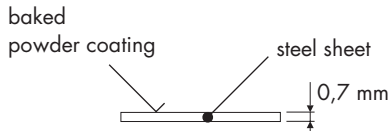

Lockers on the bench frame

- lockers are to be connected with the help of the screws to the welded bench frame in finishing RAL7035
- bench seat material is melamine

Melamine chipboard in light grey colour.

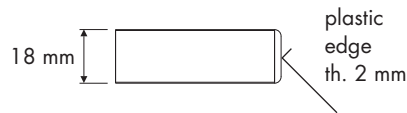

Plastic edge is identical with the colour of the top

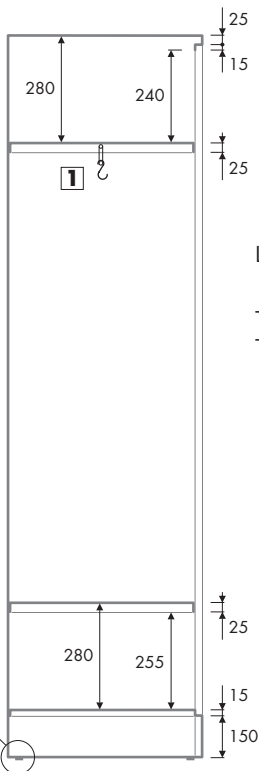
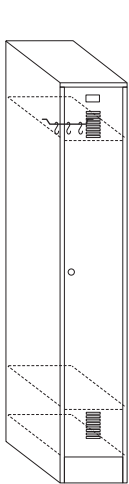

Locker's side view

- shelf placement
- placement of the bar for coat hangers with 3 plastic hooks

(locker's variant with the shelf placed in both up and down positions)

plastic gliders

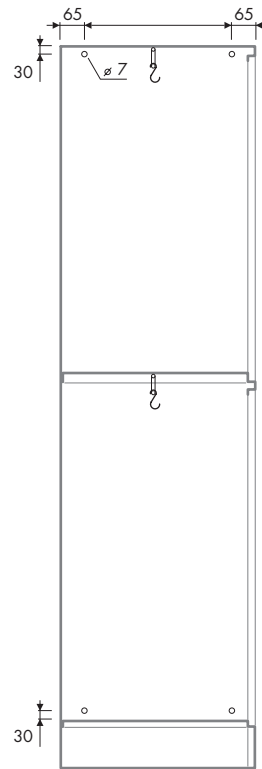
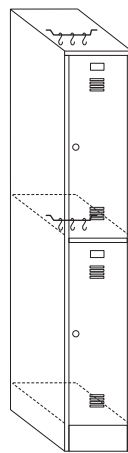

Locker's side view

- position of the side holes used for lockers connection
- placement of the bar for coat hangers to the ceiling of the locker

(lockers variant with no shelves)

LOCKERS

STANDARD COLOUR FINISHINGS

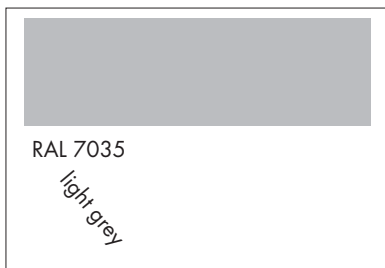

SURCHARGE COLOUR FINISHINGS

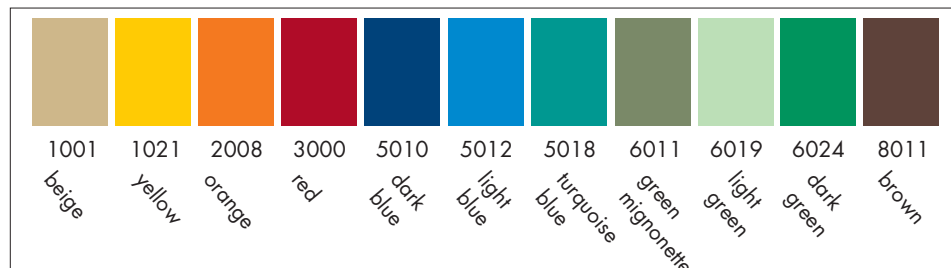



COLOUR SURCHARGE TABLE

COLOUR RAL	VOLUME OF THE ORDER IN EUR			
	ONLY DOOR (PMACD)		DOOR + CARCASS (PMACW)	
	1- 6 500 EUR*	over 6 500 EUR*	1- 6 500 EUR*	over 6 500 EUR*
7035	0,0%	0,0%	0,0%	0,0%
5012	0,0%	0,0%	0,0%	0,0%
5010	5,0%	2,5%	7,5%	5,0%
3000	5,0%	2,5%	7,5%	5,0%
1021	5,0%	2,5%	7,5%	5,0%
3024	5,0%	2,5%	7,5%	5,0%
6019	5,0%	2,5%	7,5%	5,0%
6011	5,0%	2,5%	7,5%	5,0%
5018	5,0%	2,5%	7,5%	5,0%
8011	5,0%	2,5%	7,5%	5,0%
1001	5,0%	2,5%	7,5%	5,0%
2008	5,0%	2,5%	7,5%	5,0%

* - the colour surcharge is calculated from the price of the locker stated in the price list



COLOUR FINISHINGS

Example of the application	Description	Art. No.	Price EUR
COLOUR SURCHARGE - ONLY DOOR			
	Colour finishing - only door in colour RAL...	PMACD	**,-
COLOUR SURCHARGE - DOOR + CARCASS			
	Colour finishing - door + carcass in colour RAL...	PMACW	**,-

** - to find the price, please follow the colour surcharge table on the previous page



Presented material colours are only orientational and depend on the quality of printing.

LOCKERS

PRICE LIST

Dimensions are stated in millimetres. The products weight allowance is $\pm 5\%$.

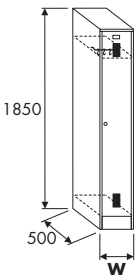
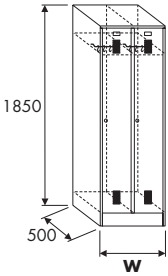
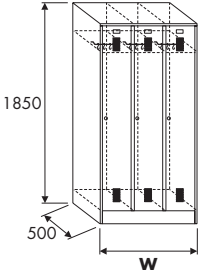
Schema	Description	Weight	Dimen- sions		Art. No.	Price
			Kg	W		
<p>ON A PEDESTAL height 1850 mm</p> 	One-door locker on a pedestal	25,2	300	PMW13S	117,30	
		28,8	400	PMW14S	141,80	
	Two-doors locker on a pedestal	41,2	500	PMW25S	176,40	
		42,7	600	PMW26S	181,00	
		49,4	800	PMW28S	220,30	
	Three-doors locker on a pedestal	55,8	750	PMW37S	262,00	
		60,4	900	PMW39S	264,00	

LOCKERS

PRICE LIST

Dimensions are stated in millimetres. The products weight allowance is $\pm 5\%$.

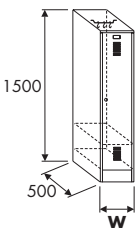
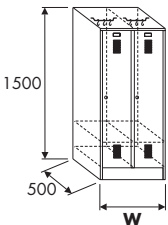
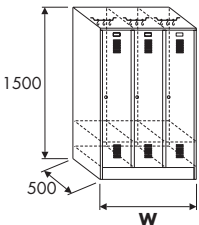
Schema	Description	Weight	Dimen- sions		Art. No.	Price
			Kg	W		
<p>ON A PEDESTAL height 1500 mm</p> 	One-door locker on a pedestal	21,2	300	PMW13M	105,70	
		25,3	400	PMW14M	126,50	
	Two-doors locker on a pedestal	34,0	500	PMW25M	157,60	
		35,2	600	PMW26M	166,20	
		42,1	800	PMW28M	202,40	
	Three-doors locker on a pedestal	47,1	750	PMW37M	225,00	
		51,2	900	PMW39M	237,60	

LOCKERS
PRICE LIST

 Dimensions are stated in millimetres. The products weight allowance is $\pm 5\%$.

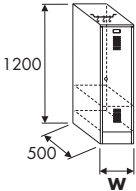
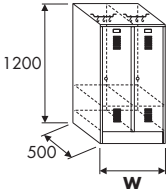
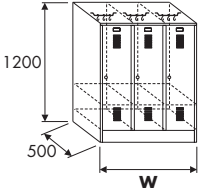
Schema	Description	Weight	Dimen- sions		Art. No.	Price
			Kg	W		
ON A PEDESTAL height 1200 mm 	One-door locker on a pedestal					
		18,0	300		PMW13L	89,20
		21,2	400		PMW14L	114,00
	Two-doors locker on a pedestal					
		28,3	500		PMW25L	132,90
		30,0	600		PMW26L	137,60
		35,3	800		PMW28L	164,10
	Three-doors locker on a pedestal					
		37,8	750		PMW37L	196,80
		42,3	900		PMW39L	200,80

LOCKERS

PRICE LIST

Dimensions are stated in millimetres. The products weight allowance is $\pm 5\%$.

Schema	Description	Weight	Dimen- sions	Art. No.	Price
		Kg	W		EUR
ON A BENCH FRAME					
	Two-doors locker on a bench frame	49,5	500	PMW25B	240,20
		53,0	600	PMW26B	244,90
		62,6	800	PMW28B	287,20
ON A BENCH FRAME					
	Three-doors locker on a bench frame	65,6	750	PMW37B	295,60
		74,2	900	PMW39B	304,60
ON A PEDESTAL					
<p>Note:.. locker is divided by vertical partition in relation 1:1.</p>	Two-doors locker on a pedestal				
	- 3-way lock common for both doors	40,5	500	PMWD25S	178,70
		44,0	600	PMWD26S	183,30
- 1x vertical partition - 2x shelves - 6x hooks	50,6	800	PMWD28S	215,50	

LOCKERS
PRICE LIST



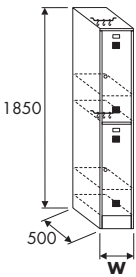
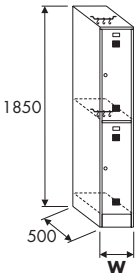
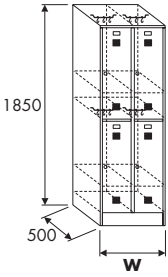
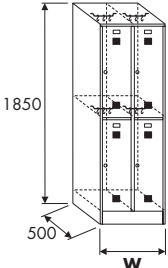

 Dimensions are stated in millimetres. The products weight allowance is $\pm 5\%$.

Schema	Description	Weight	Dimen- sions		Art. No.	Price
			Kg	W		
ON A PEDESTAL height 1850 mm 	Two-doors locker on a pedestal equipped with a shelf	27,5	300		PMW23S	152,50
	Two-doors locker on a pedestal without shelf	25,3	300		PMW23SF	145,10
	Four-doors locker on a pedestal equipped with a shelf	42,6	500		PMW45S	223,92
		45,7	600		PMW46S	228,80
	Four-doors locker on a pedestal without shelf	38,6	500		PMW45SF	216,40
		40,5	600		PMW46SF	221,10

LOCKERS

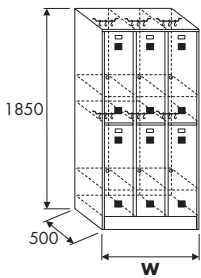
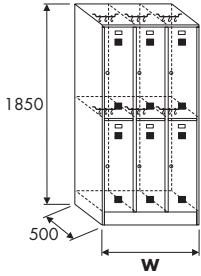
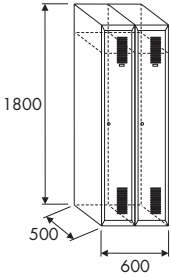
PRICE LIST

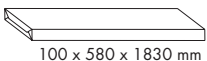
Dimensions are stated in millimetres. The products weight allowance is ± 5%.

Schema	Description	Weight	Dimen- sions		Art. No.	Price	
			Kg	W			
ON A PEDESTAL	height 1850 mm					EUR	
	Six-doors locker on a pedestal equipped with a shelf	60,4	750		PMW67S	327,10	
		65,0	900		PMW69S	342,90	
	Six-doors locker on a pedestal without shelf	54,8	750		PMW67SF	317,40	
		58,4	900		PMW69SF	321,70	
SPECIAL OFFER - KNOCK-DOWN STATE							
	Two-doors locker						
	colour finishing	43,0	600	RAL 7035	A1008 🔒	165,30	
	- light grey RAL 7035	43,0	600	RAL 7035	A1018 🔓	165,30	
	Delivery:  - disassembled state in box						
	 100 x 580 x 1830 mm	43,0	600	Carcass 7035 Door 5005	A1008 🔒	165,30	
 43,0 kg	43,0	600	Carcass 7035 Door 5005	A1018 🔓	165,30		

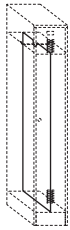
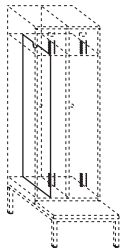
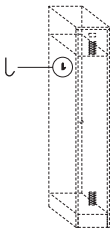

Dimensions are stated in millimetres.



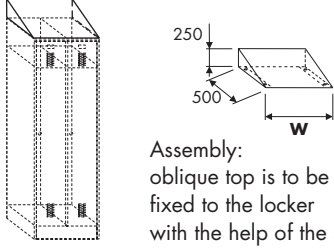
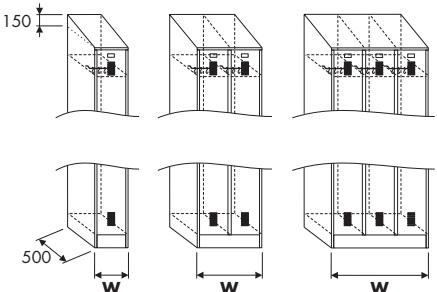
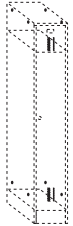
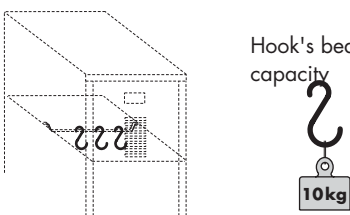

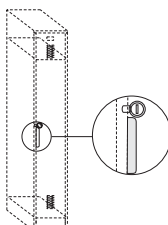
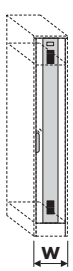

Schema	Description	Dimensions	Art. No.	Price
SHELF		W		EUR
 <p>It is possible to place the shelf up or down inside the locker.</p>	Additional shelf for one locker's cell in colour finishing RAL7035	250	PMWAS2	4,30
	Has to be ordered together with the carcass, it's not possible to order additionally.	300	PMWAS3	4,40
		400	PMWAS4	5,60
INNER PARTITION WALL				
 <p>Inner partition wall divides the space of the locker in a relation 1:1.</p> <p>Available only for modules 400 mm.</p>	Inner partition wall for one locker's cell on a pedestal, height 1850 mm. Colour finishing same as carcass. Has to be ordered together with the carcass, it's not possible to order additionally.		PMWADPS	19,70
 <p>Inner partition wall divides the space of the locker in a ratio 1:1.</p> <p>Available only for modules 400 mm.</p>	Inner partition wall for one locker's cell on a bench frame, height 1700 mm. Colour finishing same as carcass. Has to be ordered together with the carcass, it's not possible to order additionally.		PMWADPB	19,50
WELDED METAL HOOK				
 <p>Has to be ordered together with the carcass, it's not possible to order additionally</p>	Metal hook - welded on the locker's wall (usually placed 1400 mm above the floor of the locker room)		PMWAMH	1,-

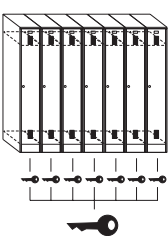
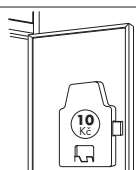
Dimensions are stated in millimetres.

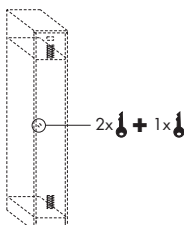
Schema	Description	Dimensions	Art. No.	Price	
OBLIQUE TOP FOR LOCKERS					
 <p>Assembly: oblique top is to be fixed to the locker with the help of the screws</p>	Oblique top for the lockers - including connection fittings in colour finishing: - light grey RAL7035 Universal both for the locker and locker-box	W		EUR	
		500		PMWAR5	28,50
		600		PMWAR6	30,60
		750		PMWAR7	32,60
		800		PMWAR8	33,70
		900		PMWAR9	35,40
SURCHARGE FOR THE OBLIQUE CARCASS					
	To be ordered only with the locker				
		300		PMWR3	13,30
		400		PMWR4	13,40
		500		PMWR5	18,70
		600		PMWR6	18,80
		750		PMWR7	28,00
		800		PMWR8	23,40
900		PMWR9	28,10		
SIDE HOLES FOR LOCKERS CONNECTION					
 <p>Note: including galvanized connection bolts M6x15 and nuts M6</p>	Side holes for locker's connection including connection fittings Art. No. and the price is valid for one locker			PVRT	4,40
PLASTIC HOOK					
 <p>Hook's bearing capacity</p>	Plastic hook Note: lockers are standardly equipped with 3 hooks.			PMWAPH	0,30

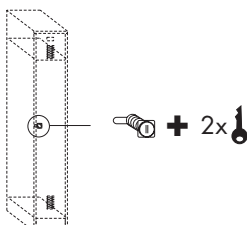
Dimensions are stated in millimetres.

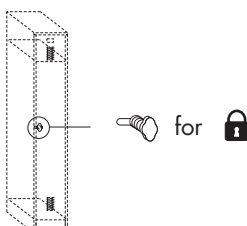
Schema	Description	Dimensions	Art. No.	Price
LOCK REINFORCEMENT				
 <p>Has to be ordered together with the carcass, it's not possible to order additionaly</p>	<p>Lock reinforcement</p> <ul style="list-style-type: none"> - preventing forced entry, door breakthrough 	<p>W</p>	<p>PMWAFL</p>	<p>1,00</p>
DOOR REINFORCEMENT				
 <p>Has to be ordered together with the carcass, it's not possible to order additionaly</p> <p>Including the lock reinforcement MWAFL</p>	<p>Door reinforcement</p> <ul style="list-style-type: none"> - door from steel sheet th. 1 mm - reinforcement of the entire height of the door - preventing forced entry, door breakthrough 	<p>250</p>	<p>PMWASK2</p>	<p>9,50</p>
		<p>300</p>	<p>PMWASK3</p>	<p>9,60</p>
		<p>400</p>	<p>PMWASK4</p>	<p>11,40</p>
SEMI-FINISHED KEY				
	<p>Semi-finished key for the cylindrical lock</p>		<p>PMWAPK</p>	<p>1,40</p>
MASTER KEY				
	<p>Master key for the cylindrical lock</p>		<p>PMWAGK</p>	<p>9,80</p>
COIN LOCK				
 <p>Cannot be ordered separately, has to be ordered together with lock For the coin 10 Kč.</p>	<p>Coin lock</p> <p>Cannot be used for the door with full reinforcement</p>		<p>PMZ</p>	<p>47,00</p>

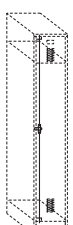
Schema	Description	Art. No.	Price EUR
<p>THE THIRD KEY FOR ONE LOCKER'S CELL</p>  <p>Third key</p> <p>2x  + 1x </p> <p>Cylindrical lock standardly includes 2 keys.</p>	<p>The third key for one locker's cell</p>	PMWA3K	1,90
<p>CYLINDRICAL LOCK</p>  <p>2x  + 1x </p>	<p>Cylindrical lock including 2 keys and a one-way latch</p>	PMWACL	4,80
<p>PADLOCK FASTENING</p>  <p>1x  for </p> <p>Note: Padlock is not included.</p>	<p>Padlock fastening with a one-way latch</p>	PMWAPL	4,80
<p>THREE-WAY LOCK</p>  <p>Additional espagnolette fastening to the bottom and to the ceiling</p> <p>- preventing forced entry, door breakthrough</p>	<p>Three-way lock for one locker's cell</p> <p>Has to be ordered together with the door and carcass, it's not possible to order additionally</p>	PMWAL3	7,60

LOCKERS - ALTERNATIVE DOOR
PRICE LIST

 Dimensions are stated in millimetres. The products weight allowance is $\pm 5\%$.

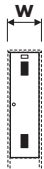
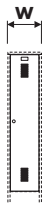
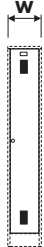
Schema	Description	Weight	Dimen- sions		Art. No.	Price
			Kg	W		
ALTERNATIVE DOOR for the locker 1200 mm  W - one cell's width	Alternative door for lockers on a pedestal without the lock, in colour finishing: - light grey RAL 7035 For other colour finishings please see the table on the page 2.	2,0 2,3 2,9	250 300 400	PMWAD23 PMWAD33 PMWAD43	15,90 17,00 18,50	
ALTERNATIVE DOOR for the locker 1500 mm  W - one cell's width	Alternative door for lockers on a pedestal without the lock, in colour finishing: - light grey RAL 7035 For other colour finishings please see the table on the page 2.	2,6 3,0 3,9	250 300 400	PMWAD24 PMWAD34 PMWAD44	17,10 18,00 21,10	
ALTERNATIVE DOOR for the locker 1850 mm  W - one cell's width	Alternative door for lockers on a pedestal without the lock, in colour finishing: - light grey RAL 7035 For other colour finishings please see the table on the page 2.	3,4 3,9 5,0	250 300 400	PMWAD2 PMWAD3 PMWAD4	18,70 20,20 24,70	

Art. No. and the price is valid for 1 pcs of door without the lock in colour finishing RAL7035 light grey.

LOCKERS - ALTERNATIVE DOOR

PRICE LIST

Dimensions are stated in millimetres. The products weight allowance is ± 5%.

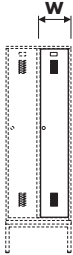
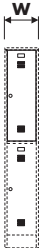
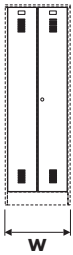
Schema	Description	Weight		Dimensions		Art. No.	Price
		Kg		W			
<p>ALTERNATIVE DOOR</p> <p>for the locker on a bench frame</p>  <p>W - one cell's width</p>	<p>Alternative door for lockers on a bench frame</p> <p>without the lock, in colour finishing: - light grey RAL 7035</p> <p>For other colour finishings please see the table on the page 2.</p>	<p>3,3</p> <p>3,8</p> <p>4,9</p>	<p>250</p> <p>300</p> <p>400</p>			<p>PMWAD25</p> <p>PMWAD35</p> <p>PMWAD45</p>	<p>18,10</p> <p>20,10</p> <p>24,20</p>
<p>for the locker 1850 mm with two doors</p>  <p>W - one cell's width</p>	<p>Alternative door for lockers on a pedestal with 2 doors</p> <p>without the lock, in colour finishing: - light grey RAL 7035</p> <p>For other colour finishings please see the table on the page 2.</p>	<p>1,3</p> <p>1,5</p>	<p>250</p> <p>300</p>			<p>PMWAD22</p> <p>PMWAD32</p>	<p>14,90</p> <p>16,00</p>
<p>left right</p>  <p>Valid for the lockers: MWD25S, MWD26S, MWD28S</p> <p>W - locker's width</p>		<p>3,6</p> <p>3,5</p> <p>4,1</p> <p>4,0</p> <p>5,2</p> <p>5,1</p>	<p>500</p> <p>600</p> <p>800</p>	<p>left</p> <p>right</p> <p>left</p> <p>right</p> <p>left</p> <p>right</p>	<p>PMWAD5L</p> <p>PMWAD5R</p> <p>PMWAD6L</p> <p>PMWAD6R</p> <p>PMWAD8L</p> <p>PMWAD8R</p>	<p>16,70</p> <p>19,60</p> <p>18,10</p> <p>21,10</p> <p>21,60</p> <p>22,50</p>	

Art. No. and the price is valid for 1 pcs of door without the lock in colour finishing RAL7035 light grey.

BOXES

TECHNICAL SPECIFICATION

SURFACE FINISHING same as the surface finishing of lockers
COLOUR FINISHING same as the colour finishing of lockers

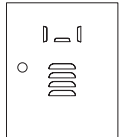

The door includes:
 - nomeplate stiffening
 - locking as preferred

Surcharge: vent holes

Locker-boxes can be used for storing of
 - small things of everyday use
 - shoes and bags
 - textbooks

Surcharge:
 - oblique top or
 oblique carcass
 prevent from placing
 things on the lockers
 and help to
 maintain tidiness



Reduction of noisiness
 - softening
 silicone lenses

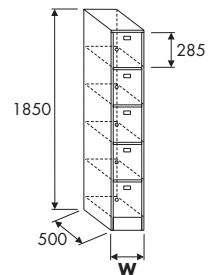
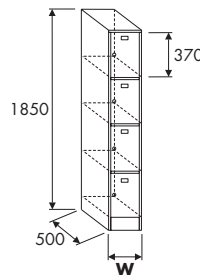
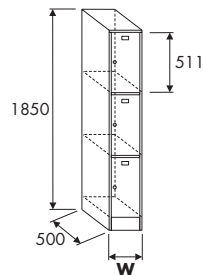

The possibility of choosing locking is included in the base price

cylindrical
 lock +
 2x

padlock
 fastening
 (padlock not incl.)

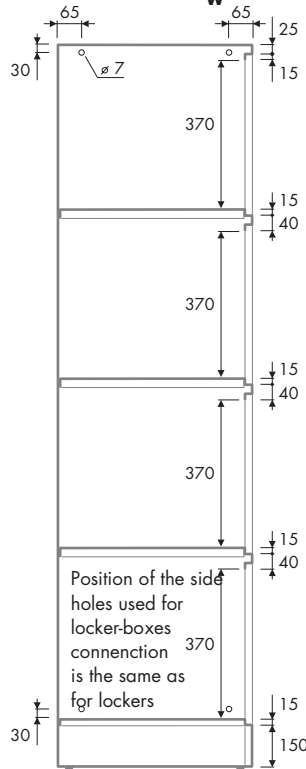
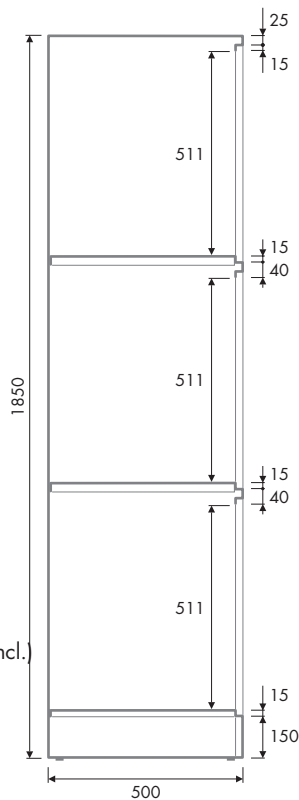

Position of the side
 holes used for
 locker-boxes
 connenction
 is the same as
 for lockers

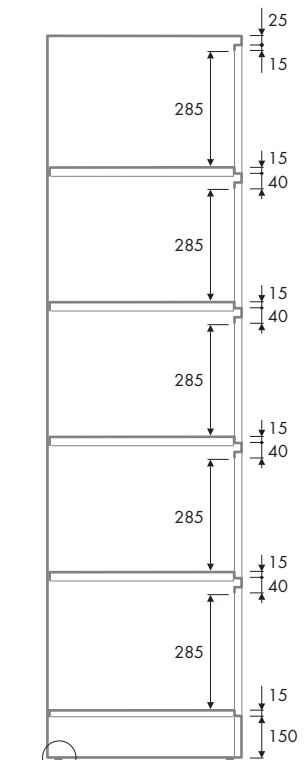

plastic
 gliders

Locker-boxes' side view

WELDED BOXES
PRICE LIST

 Dimensions are stated in millimetres. The products weight allowance is $\pm 5\%$.

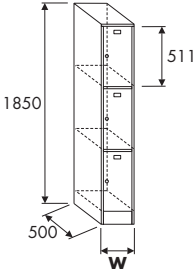
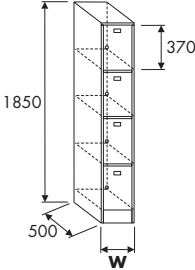
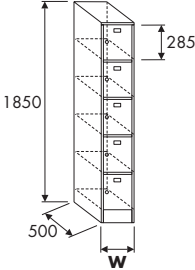
Schema	Description	Weight	Dimensions	Art. No.	Price
ON A PEDESTAL	height 1850 mm	Kg	W		EUR
 <p>Note: inner height of the box is 511 mm</p>	Locker-box on a pedestal - 3 boxes	25,5	300	PMB33S	165,20
 <p>Note: inner height of the box is 370 mm</p>	Locker-box on a pedestal - 4 boxes	27,0	300	PMB43S	175,50
 <p>Note: inner height of the box is 285 mm</p>	Locker-box on a pedestal - 5 boxes	28,5	300	PMB53S	203,80

WELDED BOXES

PRICE LIST

Dimensions are stated in millimetres. The products weight allowance is $\pm 5\%$.

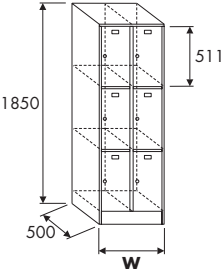
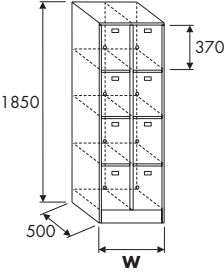
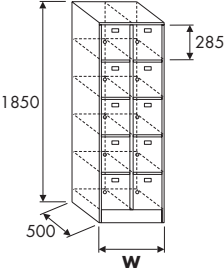
Schema	Description	Weight	Dimensions	Art. No.	Price
ON A PEDESTAL	height 1850 mm	Kg	W		EUR
	Locker-box on a pedestal - 6 boxes	42,6	600	PMB66S	255,30
Note: inner height of the box is 511 mm					
	Locker-box on a pedestal - 8 boxes	45,1	600	PMB86S	291,30
Note: inner height of the box is 370 mm					
	Locker-box on a pedestal - 10 boxes	48,5	600	PMB06S	322,80
Note: inner height of the box is 285 mm					

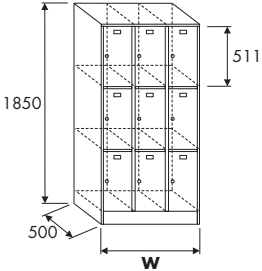
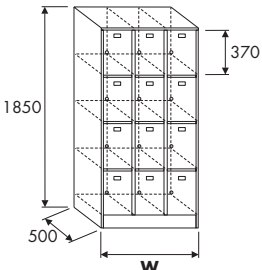
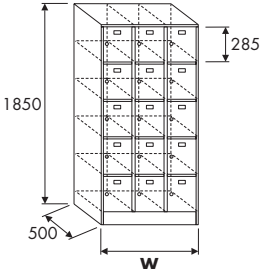

WELDED BOXES
PRICE LIST

 Dimensions are stated in millimetres. The products weight allowance is $\pm 5\%$.

Schema ON A PEDESTAL height 1850 mm	Description	Weight Kg	Dimensions W	Art. No.	Price EUR
 <p>Note: inner height of the box is 511 mm</p>	Locker-box on a pedestal - 9 boxes	66,5	900	PMB99S	373,50
 <p>Note: inner height of the box is 370 mm</p>	Locker-box on a pedestal - 12 boxes	70,0	900	PMB29S	415,80
 <p>Note: inner height of the box is 285 mm</p>	Locker-box on a pedestal - 15 boxes	74,0	900	PMB59S	469,10

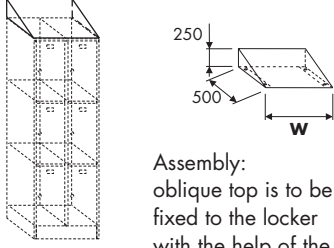
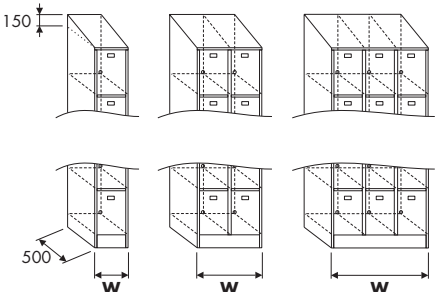
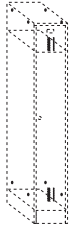
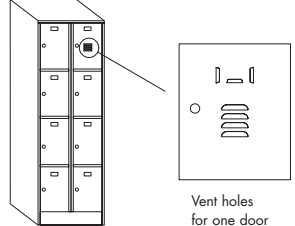

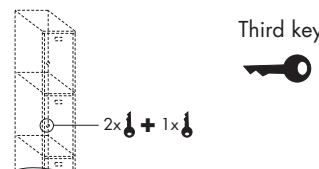
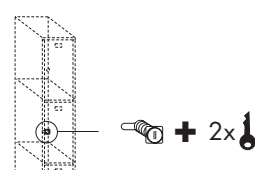
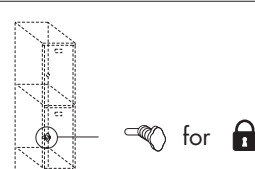
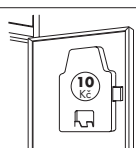
Dimensions are stated in millimetres

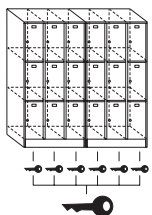
Schema	Description	Dimensions	Art. No.	Price
OBLIQUE TOP FOR LOCKER-BOXES				
 <p>Assembly: oblique top is to be fixed to the locker with the help of the screws</p>	Oblique top including connecting fittings in colour finishing: - light grey RAL 7035 Universal for both locker and locker-box.	600	PMWAR6	30,60
		900	PMWAR9	35,40
SURCHARGE FOR THE OBLIQUE CARCASS				
	Surcharge for the oblique carcass Has to be ordered together with the locker	300	PMBR3	13,30
		600	PMBR6	18,80
		900	PMBR9	28,10
HOLES FOR LOCKERS CONNECTION				
 <p>Note: including galvanized connecting bolts M6x15 and nuts M6</p>	Side holes for locker's connection including connecting fittings Art. No. and the price is valid for one locker		PVRT	4,40
VENT HOLES				
 <p>Vent holes for one door</p>	4 vent holes for one door of the locker-box Note: Art. No. and the price is valid for vent holes to one door		PMBAV	2,50

Schema	Description	Art. No.	Price
THE THIRD KEY FOR ONE LOCKER'S CELL			
 <p>Third key</p>	<p>The third key for cylindrical lock.</p> <p>Cylindrical lock standardly includes 2 keys.</p>	PMWA3K	1,90
CYLINDRICAL LOCK			
	<p>Cylindrical lock including 2 keys and a one-way latch</p>	PMWACL	4,80
PADLOCK FASTENING			
	<p>Padlock fastening with one-way latch</p> <p>Padlock is not part of the delivery.</p>	PMWAPL	4,80
COIN LOCK			
 <p>Cannot be ordered separately, has to be ordered together with the locker. For the coin 10 Kč.</p>	<p>Coin lock</p>	PMZ	47,10
SEMI-FINISHED KEY			
 <p>Semi-finished key for the cylindrical lock</p>	<p>Semi-finished key</p>	PMWAPK	1,40
MASTER KEY			
 <p>Master key for the cylindrical lock</p>	<p>Master key for one order</p>	PMWAGK	9,80

LOCKER-BOXES - ALTERNATIVE DOOR
PRICE LIST

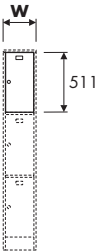
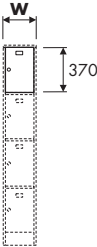
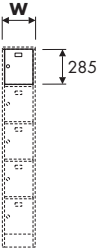
 Dimensions are stated in millimetres. The products weight allowance is $\pm 5\%$.

Schema	Description	Weight	Dimensions	Art. No.	Price
ALTERNATIVE DOOR		Kg	W		EUR
 <p>For locker-boxes: PMB33S PMB66S PMB99S</p> <p>W - one cell's width</p>	Alternative door for welded locker-boxes on a pedestal. Without lock, in colour finishing: - light grey RAL 7035. Other colour finishings according to the table on the page 2.	1,0	300	PMBAD33	8,40
 <p>For locker-boxes: PMB43S PMB86S PMB29S</p> <p>W - one cell's width</p>	Alternative door for welded locker-boxes on a pedestal. Without lock, in colour finishing: - light grey RAL 7035. Other colour finishings according to the table on the page 2.	0,8	300	PMBAD34	6,50
 <p>For the locker-boxes: PMB53S PMB06S PMB59S</p> <p>W - one cell's width</p>	Alternative door for welded locker-boxes on a pedestal. Without lock, in colour finishing: - light grey RAL 7035. Other colour finishings according to the table on the page 2.	0,6	300	PMBAD35	6,00
Art. No. and the price are valid for 1 pcs of the door without lock in colour finishing light grey RAL7035 Standard surcharge for the vent holes. Doors are supplied without hinge pivots and cases.					
FITTING					
 <p>Alternative doors are supplied without hinge pivots.</p>	Hinge pivot			PMBP	0,50
 <p>Alternative doors are supplied without hinge pivot cases</p>	Hinge pivot case			PMBB	0,80

CLOAKROOM BENCHES

PRICE LIST

Dimensions are stated in millimetres. The products weight allowance is $\pm 5\%$.

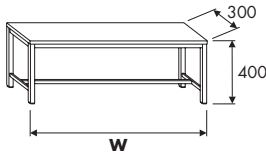
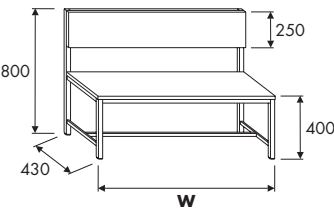
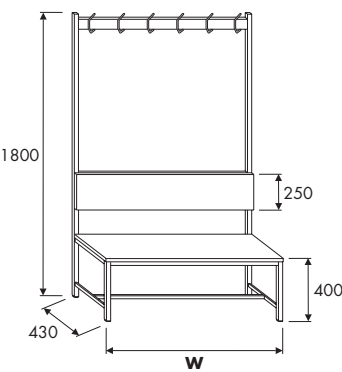
Schema	Description	Weight		Dimensions	Number of hangers	Art. No.	Price
		Kg	W				
<p>INTO SPACE</p> <p>Welded legs with cross profiles, longitudinal profiles screwed.</p>  <p>Note: standardly supplied in disassembled state.</p>	Cloakroom benches into space						
	- self-supporting metal base	14,8	1000			B1003	89,60
	colour finishing grey RAL 7035	20,1	1500			B1503	108,10
	- seat: laminate chipboard grey, th. 18 mm, ABS edge grey th. 2 mm	25,3	2000			B2003	125,20
 <p>Note: standardly supplied in assembled state.</p>	Cloakroom bench with back						
	- self-supporting metal base	26,0	1000			PB1004O	152,00
	colour finishing grey RAL 7035	36,5	1500			PB1504O	171,60
	- seat and back: laminate chipboard grey th. 18 mm, ABS edge grey th. 2 mm	46,0	2000			PB2004O	205,90
 <p>Note: standardly supplied in assembled state.</p>	Cloakroom bench with hangers						
	- self-supporting metal base	32,6	1000		6	PB1004V	230,40
	colour finishing grey RAL 7035	44,5	1500		10	PB1504V	264,70
	- seat and back: laminate chipboard grey, th. 18 mm, ABS edge grey th. 2 mm	55,1	2000		13	PB2004V	294,10

LOCKERS FOR THE EXCHANGE OF WORKING CLOTHES

PRICE LIST

Dimensions are stated in millimetres. The products weight allowance is $\pm 5\%$.

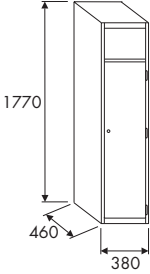
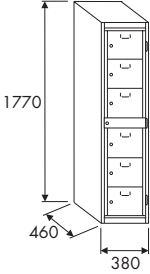
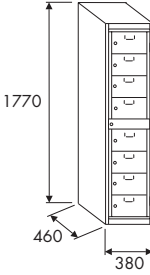
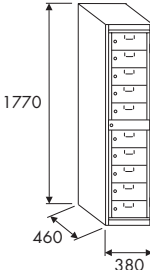
Schema	Description	Weight	Art. No.	Price
LOCKER FOR THE COLLECTION OF USED CLOTHES				
	<p>Locker for the collection of used clothes</p> <ul style="list-style-type: none"> - tipping door in upper part - equipped with perforated bars and hooks for gripping of bag - all lockers can be unlock by one key - colour finishing grey RAL 7035 	Kg 37,8	DLM2241	216,00 EUR
LOCKERS FOR THE EXCHANGE OF CLEAN CLOTHES				
	<p>6-boxes locker for the issue of clean clothes</p> <ul style="list-style-type: none"> - locking by cylindrical locks - doors are placed in centrally lockable frame - all locker frames can be unlock by one key - colour finishing grey RAL 7035 	49,7	DLM2246	435,60
	<p>8-boxes locker for the issue of clean clothes</p> <ul style="list-style-type: none"> - locking by cylindrical locks - doors are placed in centrally lockable frame - all locker frames can be unlock by one key - colour finishing grey RAL 7035 	52,6	DLM2248	464,60
	<p>10-boxes locker for the issue of clean clothes</p> <ul style="list-style-type: none"> - locking by cylindrical locks - doors are placed in centrally lockable frame - all locker frames can be unlock by one key - colour finishing grey RAL 7035 	55,6	DLM22410	501,60

Instructions for Use of Metal Furniture

(apply for the products mentioned in this catalogue)

Use of furniture, general principles:

Lockers are intended for clothes and shoes storing in workplaces, sports facilities, schools, production plants etc. Cloakroom benches are meant for sitting and placing of the clothes in cloakrooms, sports facilities, production plants etc. Lockers and benches are usually placed in interior premises with standard, dry environment, as e.g. cloakrooms, corridors etc.

Material and structure:

The material of the lockers is the sheet iron refaced with powdered burnt paint. The lockers are divided into individual cells with the closing door. Lockers carcasses are welded.

The benches are made of steel closed profiles. Finish by powdered burnt paint. The structure is partly welded and partly assembled. Seats and backs of the benches are made of laminate-chips boards with ABS edge.

Products are not intended for:

- direct contact with water or placing in moist environment
- excessive static or dynamic loading
- storing of heavy objects and objects of other nature than clothes and shoes

Locker door has vent holes (ribs), which enable air access and exhaust of possible residual moist from the stored clothes. It is not permitted to cover these ventilating holes for hygienic reasons. The holes are not meant for the object hanging! Opening and closing of the door is carried out by turning and pulling (pushing) the closing mechanism. The door has light operation, do not use the strength! If you have problems at closing, check, whether the clothes do not overlap the locker boundaries.

Put only the dry clothes in the locker! Use the hooks for placing the clothes (standard equipment, permitted loading max 10 kg), or use the hangers or possibly the shelf in the upper part of the locker.

Place the shoes on the locker bottom. In winter remove snow and ice with the remainders of gritting salt from the shoes before storing thereof or place them on the plastic tub (may be ordered as accessory). Aggressive gritting materials dissolved in water may run in the joints in the locker pedestal and may cause corrosion.

Accessories:

You can choose the accessories and side line of the locker from the seller's catalogue.

Notice:

We recommend to choose the suitable type of product with regard to its use and operational loading, after consultation with the seller. Do not overfill the lockers! In the case of the violent treatment the door may be deformed permanently or the key may be broken! Once a year check, whether the lock latch nut (on the door inner side) is not unscrewed. If it is, call the supplier's service or possibly screw the nut lightly by 12 mm spanner. It is prohibited to use the cloakroom benches in another manner than the purpose of the use thereof is. It is prohibited to step on the benches.

Maintenance Instructions for Metal Furniture

(apply for the products mentioned in this catalogue)

Maintenance of the metal furniture is considered to be cleaning of the surface from dust, stains, smudges, oils and other dirt. Use for the maintenance the standard cleaning agents for use in households, intended for plastic and metal lacquered furniture surfaces.

Notice:

Do not clean the furniture surface mechanically, do not use powdered abrasive agents. Do not use the agents on the basis of organic solvents for the metal lacquered surfaces.

DEPARTMENT PLZEŇ

MY DVA holding a.s.
Chebská 23
322 00 Plzeň-Křimice

tel.: +420 377 822 534
+ 420 377 822 562
+420 377 822 589
fax: +420 377 822 349
mobil: +420 777 768 827

e-mail: plzen@mydva.cz

DEPARTMENT PRAHA

MY DVA holding a.s.
Jankovcova 53
170 00 Praha 7

tel.: +420 220 190 630-2
fax: +420 220 190 633
mobil: +420 777 768 900

e-mail: paha@mydva.cz

DEPARTMENT BRNO

MY DVA holding a.s.
Štefánikova 49
602 00 Brno

tel.: +420 541 243 558-9
fax: +420 541 212 523
mobil: +420 777 768 837

e-mail: brno@mydva.cz

DEPARTMENT OSTRAVA

MY DVA holding a.s.
Hradní 27/37
710 00 Ostrava

fax: +420 596 220 199
mobil: +420 777 768 835

e-mail: ostrava@mydva.cz

SUBSIDIARY
SLOVENSKÁ REPUBLIKA
MY DVA Slovakia, s. r. o.
Polianky 17
841 01 Bratislava

tel.: +421 264 530 134-5
fax: +421 264 530 136
mobil: +421 905 988 304

e-mail: bratislava@mydva.sk

